



## INTRODUCTION TO TREATMENT OF TANNERY EFFLUENTS

What every tanner should know  
about effluent treatment



# **Introduction to treatment of tannery effluents**

What every tanner should know  
about effluent treatment



UNITED NATIONS INDUSTRIAL DEVELOPMENT ORGANIZATION  
VIENNA, 2011

Copyright © 2011 by the United Nations Industrial Development Organization.

The designations employed and the presentation of material in this publication do not imply the expression of any opinion whatsoever on the part of the European Union (EU) or the Secretariat of the United Nations Industrial Development Organization (UNIDO) concerning the legal status of any country, territory, city or area, or of its authorities, or concerning the delimitation of its frontiers or boundaries. Designations such as “industrialized,” “developed” or “developing” countries are used for statistical convenience and do not necessarily express a judgment about the stage reached by a particular country or area in the development process. Mention of firm names or commercial products does not imply endorsement by EU, UNIDO or the other project partners.

Materials in this publication may be freely quoted or reprinted, but acknowledgement is required, and UNIDO must receive a copy of the publication containing the quotation or reprint.

**Reduction of environmental threats and increase of exportability of Bangladeshi leather products** (Re-Tie Bangladesh) is a project co-funded by the European Commission under the SWITCH Asia Programme and implemented by the project partners: SEQUA (lead partner), bfz, BFLFEA, BTA, DCCI and UNIDO.

The paper *Introduction to treatment of tannery effluents*  
was prepared based on technical inputs by J. Buljan and I. Kral.  
Valuable contributions by G. Clonfero, M. Bosnić and F. Schmel are gratefully acknowledged.

## **Contents**

|  |    |
|--|----|
| <b>Foreword: Why this booklet?</b>                     | 6  |
| <b>1. Primary treatment</b>                            | 12 |
| 1.1 Objectives   | 12 |
| 1.2 Screening  | 12 |
| 1.2.1 Bar screening, removal of larger solids          | 12 |
| 1.2.2 Removal of grit and floating matter              | 13 |
| 1.2.3 Self-cleaning screens                            | 14 |
| 1.3 Pumping/lifting                                    | 14 |
| 1.3.1 Submersible pump                                 | 15 |
| 1.3.2 Screw (Archimedes) pump                          | 15 |
| 1.4 Fine screening                                     | 16 |
| 1.5 Equalization – homogenization – sulphide oxidation | 17 |
| 1.6 Chemical treatment (coagulation, flocculation)     | 18 |
| 1.7 Settling – primary sedimentation                   | 21 |
| 1.8 Sludge dewatering                                  | 22 |
| 1.8.1 Sludge thickener                                 | 23 |
| 1.8.2 Belt-filter press                                | 25 |
| 1.8.3 Centrifuge                                       | 26 |
| 1.8.4 Sludge-drying beds                               | 27 |
| <b>2. Biological (secondary) treatment</b>             | 29 |
| 2.1 Objective and basic principles                     | 29 |
| 2.2 Main operational parameters                        | 30 |
| 2.3 Other operational parameters                       | 31 |
| 2.4 Aeration devices                                   | 32 |
| 2.5 Aeration basins, oxidation ditch                   | 34 |
| 2.6 Secondary sedimentators                            | 36 |
| 2.7 Anaerobic biological treatment                     | 37 |
| <b>3. Advanced (tertiary) treatment</b>                | 37 |
| <b>4. Sludge handling</b>                              | 37 |
| 4.1 Mechanical sludge dewatering                       | 37 |
| 4.2 Utilization and disposal                           | 38 |
| <b>5. The issue of bad odour</b>                       | 39 |
| <b>6. Monitoring, costs, OSH, management</b>           | 42 |
| <b>7. Conclusions</b>                                  | 46 |

**Tables**

|   |    |
|---|----|
| Table 1. An example of mass balance in leather processing                     | 7  |
| Table 2. An example of average total pollution load                           | 7  |
| Table 3. An example of pollution load, conventional process                   | 9  |
| Table 4. Purification efficiency of treatment stages referred to raw effluent | 27 |
| Table 5. Characteristics of sludge dewatering equipment                       | 37 |
| Table 6. Dry matter content in sludge   | 38 |
| Table 7. Poisoning effects of hydrogen sulphide gas (H <sub>2</sub> S)        | 44 |

**Figures**

|  |    |
|--|----|
| Figure 1. Overview of the tanning industry   | 6  |
| Figure 2. Sources and types of pollutants generated in leather processing                          | 8  |
| Figure 3. Layout of in-house segregation of streams  | 10 |
| Figure 4. Flowchart of in-house segregation of streams   | 10 |
| Figure 5. Rough bar screen, side view  | 12 |
| Figure 6. Rough bar screen, operation principle  | 13 |
| Figure 7. Simple, non-aerated grit-and-floating-matter removal chamber                             | 13 |
| Figure 8. Self-cleaning, rotary-brush screen, Parkwood type  | 14 |
| Figure 9. Self-cleaning screen, hydrosieve type  | 14 |
| Figure 10. Submersible pump  | 15 |
| Figure 11. Archimedes lifting pump   | 15 |
| Figure 12. Rotary-drum (Konica) screen, outer flow   | 16 |
| Figure 13. Rotary-drum fine screen, inner flow   | 16 |
| Figure 14. Schematic view of an equalization, homogenization tank                                  | 17 |
| Figure 15. Venturi-type ejector often installed for mixing and aeration in the homogenization tank | 18 |
| Figure 16. Schematic view of the coagulation and flocculation system                               | 19 |
| Figure 17. Some simple laboratory utensils   | 20 |
| Figure 18. Cross section of a typical circular sedimentation tank                                  | 21 |
| Figure 19. Cross section of a rectangular sedimentation tank                                       | 21 |
| Figure 20. Schematic view of a dissolved-air flotation (DAF) unit                                  | 22 |
| Figure 21. Cross section of a progressing cavity pump for sludge transfer                          | 23 |
| Figure 22. Cross section of a gravity thickener  | 23 |
| Figure 23. Cross section of a recessed-plate press for sludge dewatering                           | 24 |
| Figure 24. Cross section of a belt-type press for sludge dewatering                                | 25 |
| Figure 25. Cross section of a sludge dewatering centrifuge   | 26 |
| Figure 26. Schematic views of sludge-drying beds   | 27 |
| Figure 27. Simplified flowchart of the physical-chemical (primary) tannery effluent treatment      | 28 |
| Figure 28. A simplified flow diagram of the activated sludge process                               | 30 |
| Figure 29. Surface (floating) aerators   | 32 |
| Figure 30. Cross section of floating aerator   | 33 |
| Figure 31. Forced-air, submersed turbine aerator   | 33 |
| Figure 32. Schematic diagram of oxidation ditches  | 35 |
| Figure 33. Simplified flowchart of the biological (secondary) tannery effluent treatment           | 40 |

|   |    |
|---|----|
| Figure 34. Simplified flowchart of a full-fledged tannery effluent treatment plant                  | 41 |
| Figure 35. Structure of average treatment costs at selected CETPs in India in 2005                  | 42 |
| Figure 36. Distribution of average total costs at selected CETPs in Italy                           | 42 |
| Figure 37. Schematic chart of typical effluent treatment setup for clusters in developing countries | 43 |
| Figure 38. Schematic chart of typical effluent treatment setup in industrialized countries          | 43 |
| Figure 39. An example of CETP management setup  | 45 |

## Photographs

|  |    |
|--|----|
| Photo 1. Coagulant/flocculant dosing station                                     | 20 |
| Photo 2. "Flocs" after coagulation, flocculation                                 | 20 |
| Photo 3. Sedimentation tank (empty)  | 22 |
| Photo 4. Sedimentation tank in operation   | 22 |
| Photo 5. Recessed-plate filter press with container for dewatered sludge         | 24 |
| Photo 6. Belt press with transporter for dewatered sludge                        | 25 |
| Photo 7. Sludge dewatering centrifuge (the lid is up for better view)            | 26 |
| Photo 8. Surface aerators  | 33 |
| Photo 9. Bottom air diffuser grid with one section and fine-bubble dome diffuser | 34 |
| Photo 10. Fine-bubble difusers, dome and tubular type                            | 34 |
| Photo 11. Submersed turbine aerators in oxidation ditch                          | 35 |
| Photo 12. Oxidation ditch in operation   | 36 |
| Photo 13. Containers for solid waste   | 38 |

## Annexes

|   |    |
|---|----|
| Annex 1. General view of inputs and outputs in the leather sector                   | 48 |
| Annex 2. Chrome-recovery unit using NaOH  | 48 |
| Annex 3. Classification of pumps  | 49 |
| Annex 4. A model of rotary screening drum   | 50 |
| Annex 5. Types of sedimentation tanks   | 50 |
| Annex 6. Photos and cross section of a circular sedimentation tank                  | 51 |
| Annex 7. Sludge production in leather processing                                    | 51 |
| Annex 8. Classification of mechanical aerators                                      | 52 |
| Annex 9. Scheme of the membrane bioreactor (MBR)                                    | 53 |
| Annex 10. Personal hydrogen-gas monitor   | 53 |
| Annex 11. Reverse osmosis (RO): principle, diagram, photo of a small RO unit        | 54 |
| Annex 12. Schematic view of constructed wetland – reed beds                         | 55 |
| Annex 13. Aerated static composting pile  | 56 |
| Annex 14. Typical fluxogram of an ETP   | 57 |
| Annex 15. A dialogue between a tanner and an environmental engineer                 | 58 |
| Annex 16. Basic plant monitoring and control  | 59 |
| Annex 17. Discharge limits for treated tannery effluents in France, Italy and India | 60 |
| Annex 18. Typical tannery ETP auxiliary chemicals and their dosing                  | 61 |
| Annex 19. Environmental effects of the main constituents of tannery effluents       | 62 |
| Annex 20. References  | 67 |

## Foreword: Why this booklet?

Confronted with increasing legal and social pressures, no tanner can afford the luxury of not being familiar with the main issues and principles of environmental protection pertaining to tannery operations.

Obviously, pollution prevention, the persistent promotion of cleaner leather processing, which ultimately leads to lower treatment costs, remains the supreme priority.

By applying industrially proven low-waste advanced methods such as the use of salt-free preserved raw hides and skins, hair-save liming, low-ammonia or ammonia-free deliming and bating, advanced chrome management systems, etc., it is possible to decrease significantly the pollution load, namely: COD and BOD<sub>5</sub> by more than 30%, sulphides by 80-90%, ammonia nitrogen by 80%, total (Kjeldahl) nitrogen by 50%, chlorides by 70%, sulphates by 65%, and chromium by up to 90%.

Yet, despite all preventive measures, there is still a considerable amount of pollution load to be dealt with by end-of-pipe methods.

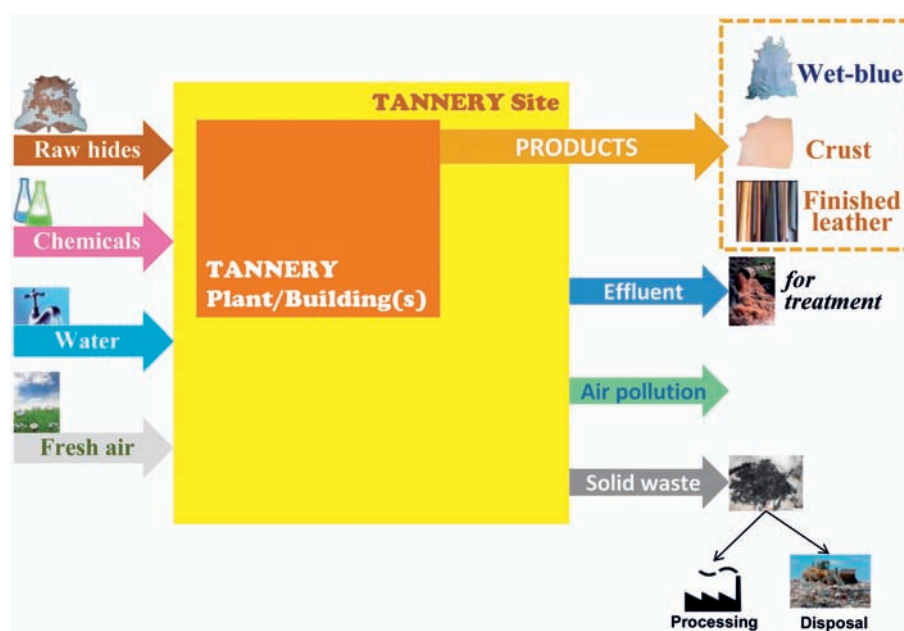

Figure 1. Overview of the tanning industry

The purpose of this booklet is to help tanners and tannery managers get acquainted with basic principles and methods of tannery effluent treatment. This knowledge should make them better equipped for a dialogue with the factory's own environmental unit, environmental authorities and NGOs.

In order to keep it short and concise, there are many simplifications and omissions of details; therefore, for an in-depth understanding of the complexities of dealing with effluents and solid wastes (sludge), it is recommended to consult the extensive literature on this subject.

Finally, there is the widespread misperception that vegetable tanning is environmentally harmless (in reality its effluents have very high, difficult to treat COD); this publication focuses on combined chrome tanning, which is by far the most prevailing leather tanning method.

## Cleaner technologies

The pressure to adopt cleaner technologies normally emanates from environmental imperatives such as the need to meet specific discharge norms, reduce treatment costs or comply with occupational safety and health standards. The typical primary targets are: lower water consumption, improved uptake of chemicals, better quality/re-usability of solid waste, and reduced content of specific pollutants such as heavy metals and electrolytes.

The spread of cleaner technologies and processes has been neither spontaneous nor extensive. For all the claims about favourable cost-benefit ratios and/or environmental benefits to be derived from many of these technologies, tanners are not quick in adopting them, be it due to inertia, higher costs or the limitations mentioned earlier.

## Pollution load

Due to variations in raw material, process, chemicals, water consumption, etc., it is small wonder that figures about pollution load in the literature vary a lot and should be interpreted very cautiously. The tables below and the chart on overleaf may give a general idea, the usual reference being one tonne of wet-salted hides.

| Example of mass balance of chemicals in leather processing<br>kg/ tonne of wet-salted hide |                  |                        |        |
|--|------------------|------------------------|--------|
| Chemicals  | Added in process | In/on leather & splits | Wasted |
| Chrome oxide, Cr <sub>2</sub> O <sub>3</sub>   | 25               | 12                     | 13     |
| Organic tannins  | 25               | 20                     | 5      |
| Fat liquors  | 22               | 17                     | 5      |
| Dyestuffs  | 5                | 4                      | 1      |
| Acids, bases, salts  | 191              | -                      | 191    |
| Tensides   | 3                | -                      | 3      |
| Enzymes  | 5                | -                      | 5      |
| Finishing products   | 100              | 12                     | 88     |
| Total  | 452              | 72                     | 380    |

Table 1. An example of mass balance in leather processing

| Parameter                     | Unit                  | Average total pollution load | Typical limits, surface waters |
|-------------------------------|-----------------------|------------------------------|--------------------------------|
| BOD <sub>5</sub>              | mg O <sub>2</sub> /l  | 2,000                        | 30-40                          |
| COD                           | mg O <sub>2</sub> /l  | 4,000                        | 125-250                        |
| Suspended solids (SS)         | mg/l                  | 2,000                        | 35-100                         |
| Cr <sup>3+</sup>              | mg Cr/l               | 150                          | 1.5-2.0                        |
| S <sup>2-</sup>               | mg S/l                | 160                          | 1.0-2.0                        |
| Total nitrogen (TKN)          | mg N/l                | 160                          | 100                            |
| Cl <sup>-</sup>               | mg Cl/l               | 5,000                        | Locally specific               |
| SO <sub>4</sub> <sup>2-</sup> | mg SO <sub>4</sub> /l | 1,400                        | Locally specific               |
| Oil and grease                | mg/l                  | 130                          | Locally specific               |
| TDS*                          | mg/l                  | 10,000                       | Locally specific               |
| pH                            |                       | 6-9                          | 5.5-9.5                        |

\* The main constituents of TDS are chlorides (Cl<sup>-</sup>) and sulphates (SO<sub>4</sub><sup>2-</sup>) listed earlier.

Table 2. An example of average total pollution load – concentration in combined raw effluent, conventional process, water consumption: 45 m<sup>3</sup>/tonne



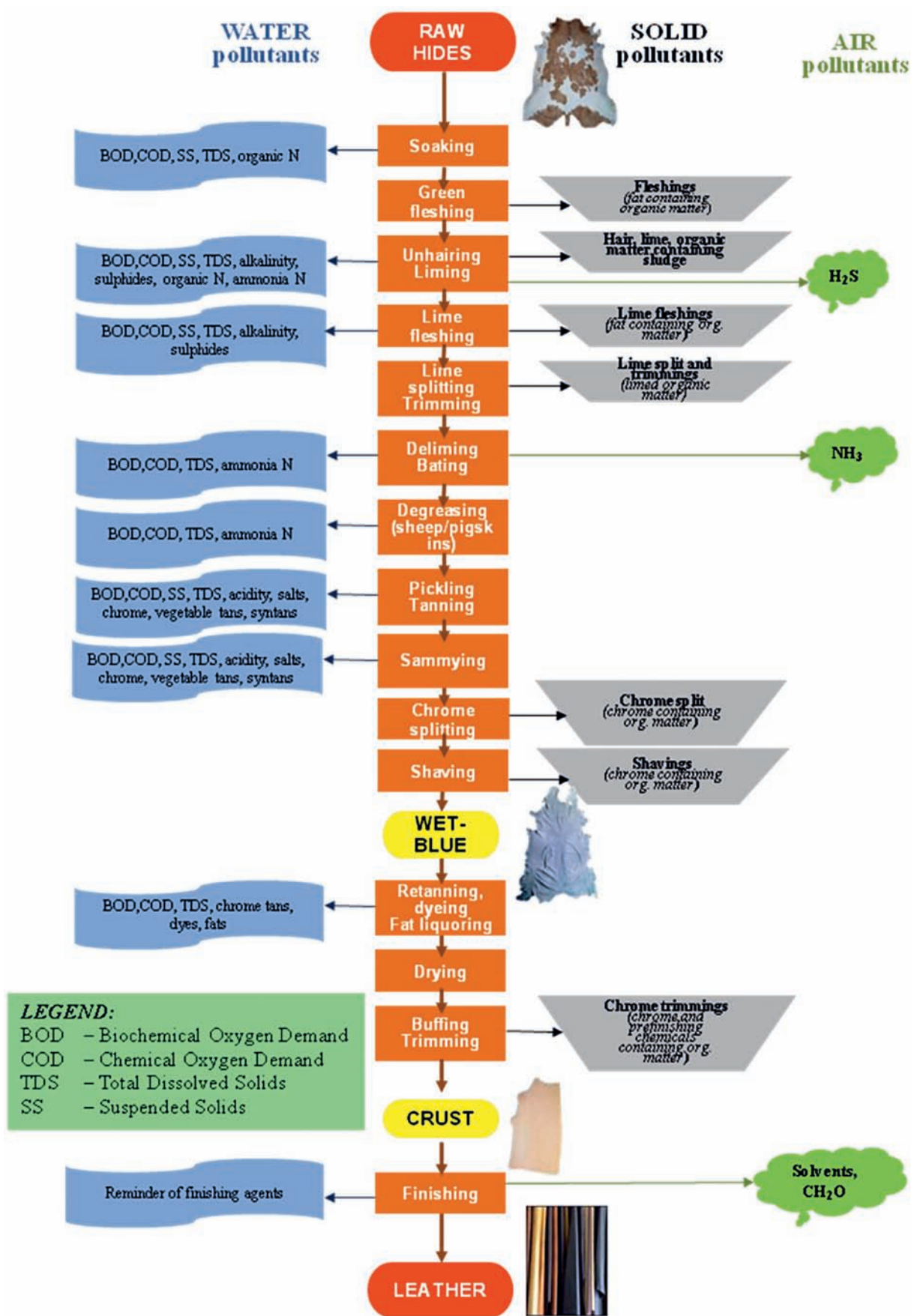

Figure 2. Sources and types of pollutants generated in leather processing

To avoid possible confusion arising due to differences in water consumption, it is practical to indicate the amount of pollutants generated per tonne of raw-hide input. While generally lower water consumption is very desirable (nowadays in well managed tanneries, it is below 30 m<sup>3</sup>/tonne), it obviously results in considerably higher concentrations of pollutants.

| Parameter                     | Typical pollution load, conventional process, kg/tonne of wet-salted hide | A tannery with a daily input of 5 t of wet-salted hides, conventional process, discharges per day approx |
|-------------------------------|---|--|
| BOD <sub>5</sub>              | 90  | 450 kg   |
| COD                           | 180   | 900 kg   |
| Suspended solids, SS          | 90  | 450 kg   |
| Cr <sup>3+</sup>              | 7   | 35 kg  |
| S <sup>2-</sup>               | 7.5   | 37.5 kg  |
| Total Nitrogen (TKN)          | 7.5   | 37.5 kg  |
| Cl <sup>-</sup>               | 225   | 1125 kg  |
| SO <sub>4</sub> <sup>2-</sup> | 63  | 315 kg   |
| Oil and grease                | 6   | 30 kg  |
| TDS*                          | 450   | 2250 kg  |
| pH                            | 6-9   |  |

\* The main constituents of TDS are chlorides (Cl<sup>-</sup>) and sulphates (SO<sub>4</sub><sup>2-</sup>) listed earlier.

**Table 3. An example of pollution load, conventional process**

## Treatment

Before turning to treatment itself, it is important to bear in mind the following:

- The design of an effluent treatment plant (ETP) is always tailored to the requirements of a specific site; thus, there are no two identical ETPs.
- Pollutants contained in effluent cannot disappear; they are only converted into something which is environmentally more acceptable or easier to dispose of (sludge).
- Somewhat paradoxically, the obvious is often overlooked: the same amount of pollutants at lower water consumption means lower hydraulic load (volume) but higher concentration – not always easy to treat.
- It is important for a tanner to understand the relation between the leather technologies applied and wastewater treatment in order to reduce the overall cost of treatment.

Wastewater treatment is a multi-stage process to purify wastewater before it enters a body of natural water, or it is applied to the land, or it is reused. The goal is to reduce or remove organic matter, solids, nutrients, Cr and other pollutants since each receiving body of water can only receive certain amounts of pollutants without suffering degradation. Therefore, each effluent treatment plant must adhere to discharge standards – limits usually promulgated by the relevant environmental authority as allowable levels of pollutants, for practical reasons expressed as BOD<sub>5</sub>, COD, suspended solids (SS), Cr, total dissolved solids (TDS) and others. The three main categories of tannery wastewater, each one having very distinctive characteristics, are:

- Effluents emanating from the beam-house – liming, deliming/bating, water from fleshing and splitting machines; they contain sulphides, their pH is high, but they are chrome-free.
- Effluents emanating from the tanyard (tanning and re-tanning, sammying) – high Cr content, acidic.
- Soaking and other general effluents, mainly from post-tanning operations (fat-liquoring, dyeing) – low Cr content.

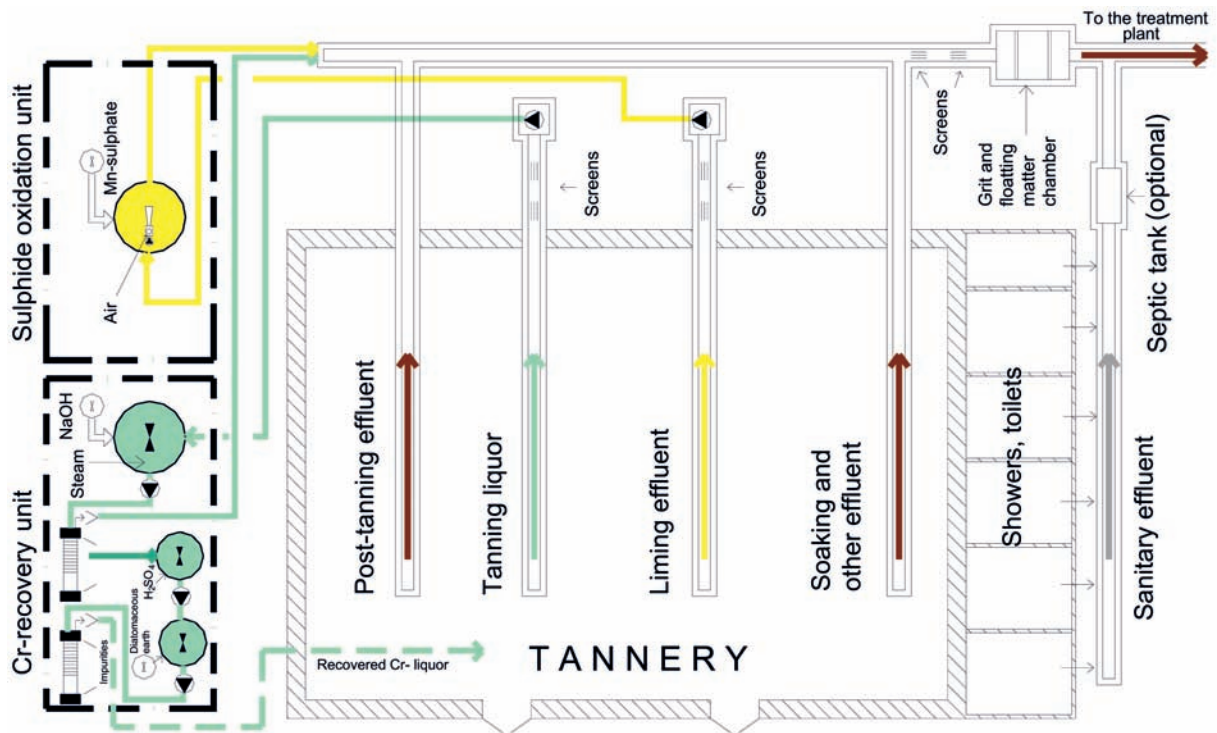

Figure 3. Layout of in-house segregation of streams, including chrome recycling and oxidation of sulphides in liming effluent

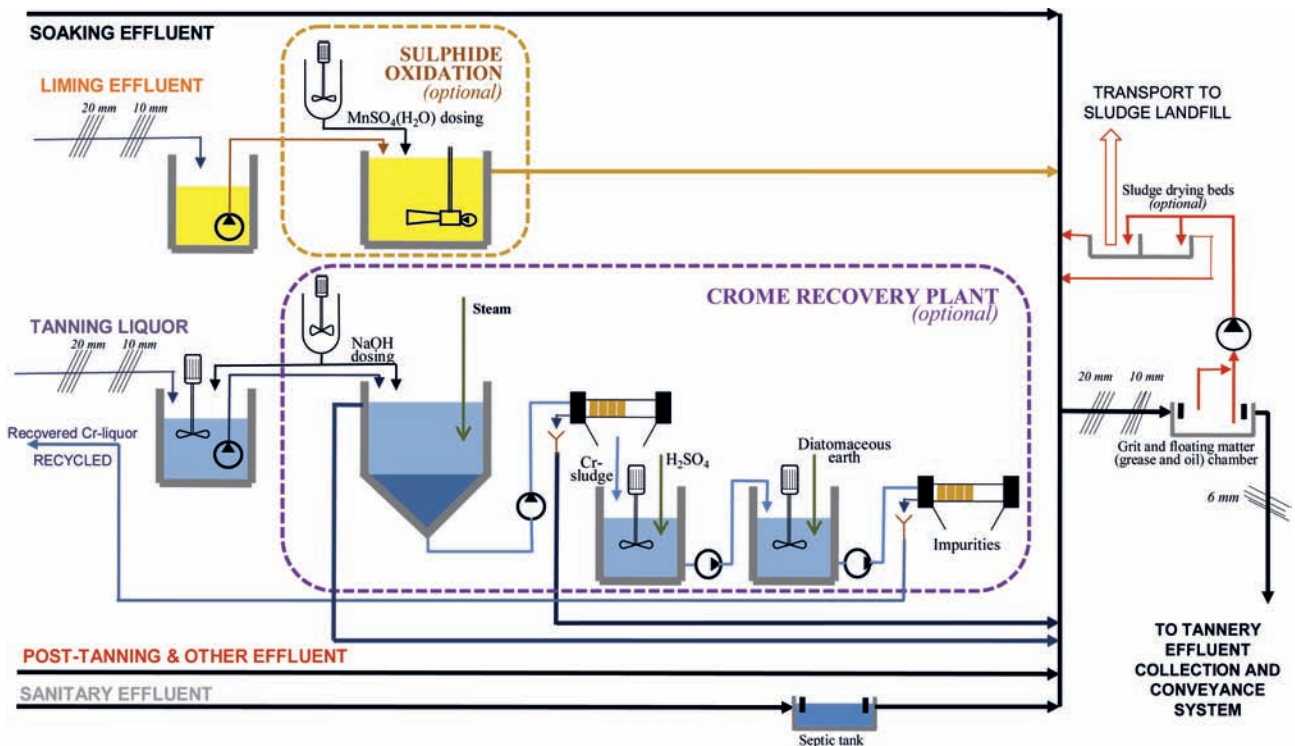

Figure 4. Flowchart of in-house segregation of streams, including chrome recycling, treatment of liming effluents and pre-treatment of mixed effluent

It is very important to segregate these streams and to pre-treat them separately according to their characteristics to avoid possible safety risks (formation of deadly hydrogen sulphide) and to reduce the cost of treatment and sludge disposal (to avoid contamination of sludge with Cr). The mixing of liming and tanning streams gives rise not only to the obnoxious smell typical of poorly managed tanneries; **the resulting lethally poisonous gas, hydrogen sulphide (H<sub>2</sub>S), is still by far the most frequent killer in tannery accidents, which occur mainly in inadequately ventilated spaces, especially in pits and channels.**

The volume and pollution load of sanitary wastewater in comparison with industrial wastewater is insignificant.

Very arbitrarily and not quite consistently we speak of the following main phases of treatment:

#### ***Preliminary treatment***

Typically, in the case of common effluent treatment plants (CETPs) servicing tannery clusters often found in developing countries, it is essential to have pre-treatment units installed in individual tanneries. Their role is to remove large particles, sand/grit and grease, but also to significantly reduce the content of chrome and sulphides before the effluent is discharged into the collection network.

#### ***Physical-chemical treatment (primary)***

The objective here is the removal of settleable organic and inorganic solids by sedimentation, and the removal of materials that will float (scum) by skimming. Approximately 25-50% of the incoming biochemical oxygen demand (BOD<sub>5</sub>), 50-70% of total suspended solids (SS), and 65% of the oil and grease are removed during primary treatment. The effluent and sludge from primary sedimentation are referred to as primary effluent and sludge.

#### ***Biological treatment (secondary)***

In most cases, secondary treatment follows primary treatment, its goal being the removal of biodegradable dissolved and colloidal organic matter using aerobic biological treatment processes. Aerobic biological treatment is carried out in the presence of oxygen by aerobic micro-organisms (principally bacteria) that metabolize the organic matter in the wastewater, thereby producing more micro-organisms and inorganic end products (principally CO<sub>2</sub>, NH<sub>3</sub>, and H<sub>2</sub>O). Several aerobic biological processes are used for secondary treatment and the differences among them have to do primarily with the manner in which oxygen is supplied to the micro-organisms and with the rate at which organisms metabolize the organic matter.

#### ***Advanced (tertiary) treatment***

Tertiary or advanced wastewater treatment is employed to reduce residual COD load and/or when specific wastewater constituents are not removed by previous treatment stages.

#### ***Sludge handling and disposal***

Effluent treatment plants produce treated, "cleaned" effluent and sludge because inherently the primary aim of wastewater treatment is the removal of solids and some potentially hazardous substances from the wastewater. Furthermore, biologically degradable organic substances are converted into bacterial cells, and the latter are removed from the wastewater.

## 1. Primary treatment

### 1.1 Objectives

- To eliminate the coarse material normally present in the raw wastewater that could clog/block pumps, pipes and possibly sewer lines.
- To mix and balance well different tannery streams and thus produce homogenized “raw material” that can be treated in a consistent manner.
- To adjust pH and eliminate toxic substances (sulphides) and avoid shock loads that can negatively affect the rather sensitive biological treatment.
- To significantly decrease the BOD/COD load and thus simplify the biological treatment phase and reduce its cost.

To summarize, the purpose is to eliminate the coarse matter, remove almost completely Cr and sulphides, remove the major part of suspended solids, and considerably reduce the BOD and COD content.

Basic steps:

Screening (bar, self-cleaning)<sup>1</sup>

Pumping/lifting

Fine screening

Equalization and sulphide oxidation

Chemical treatment (coagulation, flocculation)

Settling

Sludge dewatering<sup>2</sup>

### 1.2 Screening

#### 1.2.1 Bar screening, removal of larger solids

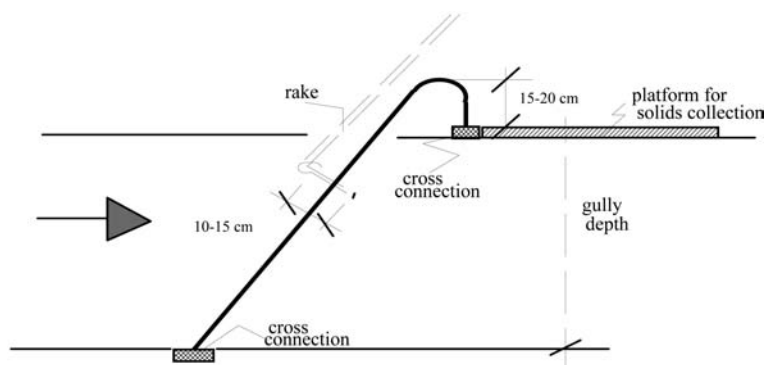

Figure 5. Rough bar screen, side view

<sup>1</sup>Quite often a grease-and-sand trap is also included, usually before fine screening and pumping.

<sup>2</sup> Primary and secondary sludge are handled/dewatered together; however, since some ETPs have only primary treatment and the main part of sludge is generated during that stage, sludge dewatering is covered here.

### 1.2.2 Removal of grit and floating matter

A simple, non-aerated grit-and-floating-matter removal chamber is usually placed in a horizontal gravity channel immediately after the rough screen.

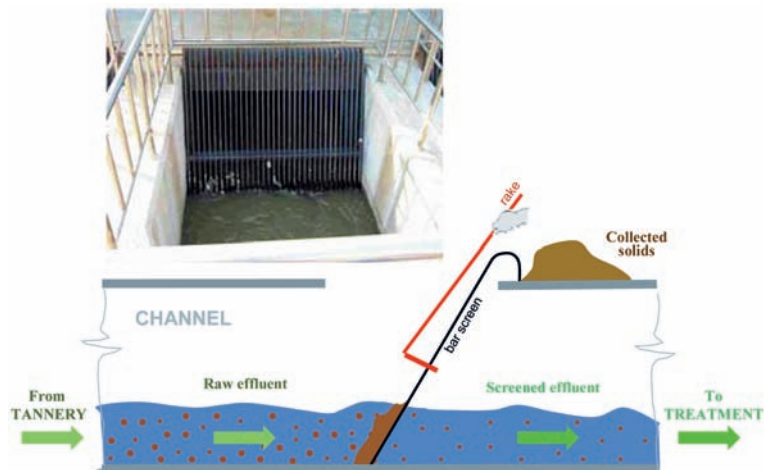

Figure 6. Rough bar screen, operation principle

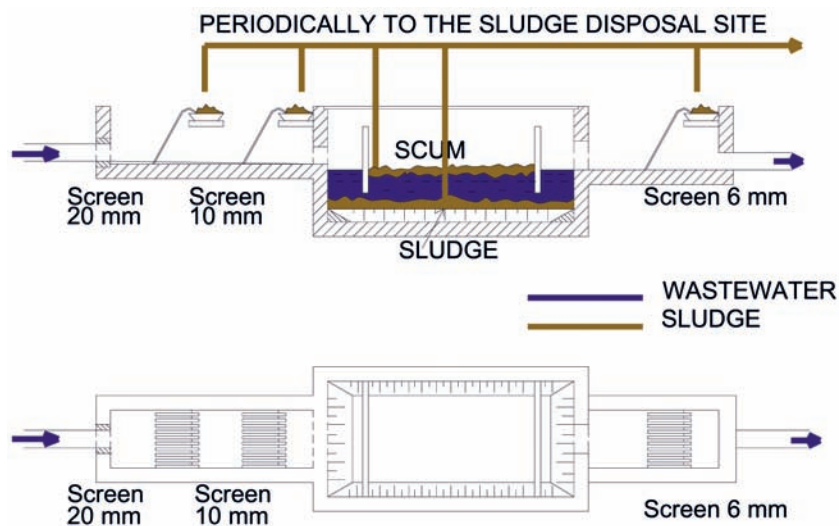

Figure 7. Simple, non-aerated grit-and-floating-matter removal chamber

Large ETPs require more sophisticated, aerated systems for the removal of grit and floating matter.

### 1.2.3 Self-cleaning screens

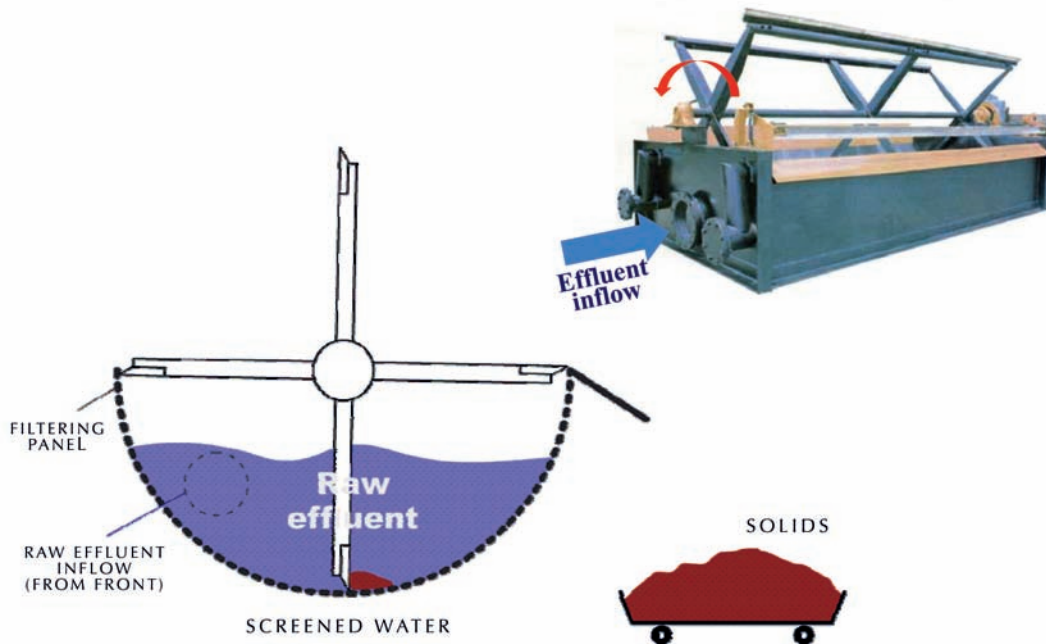

Figure 8. Self-cleaning, rotary-brush screen, Parkwood type

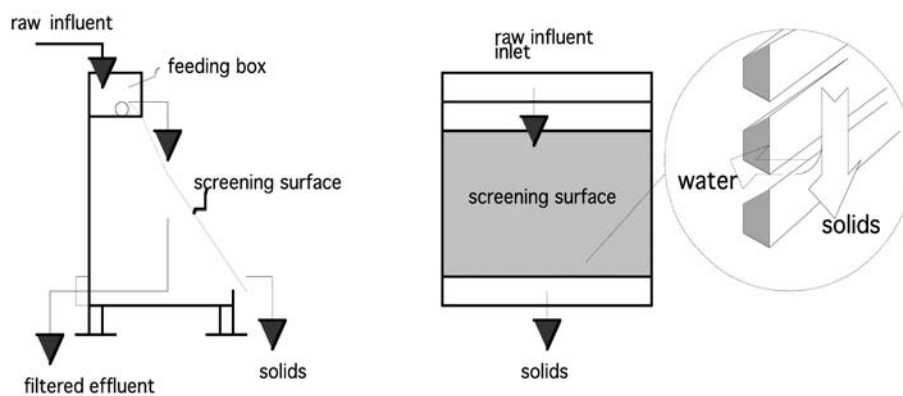

Figure 9. Self-cleaning screen, hydrosieve type

### 1.3 Pumping/lifting

It is not possible to transfer effluents throughout the ETP by gravity only; at least one, often more pumping/lifting stations are needed, the first typically located before the rotary screen. Depending on specific requirements (capacity/flow), different types of pumps are used. For medium-scale ETPs, submersible pumps are generally used for this purpose, for large-volume ones, screw (Archimedes) pumps are preferred.

The scheme of submersible pump positioning (usually with a stand-by pump) is shown below:

### 1.3.1 Submersible pump

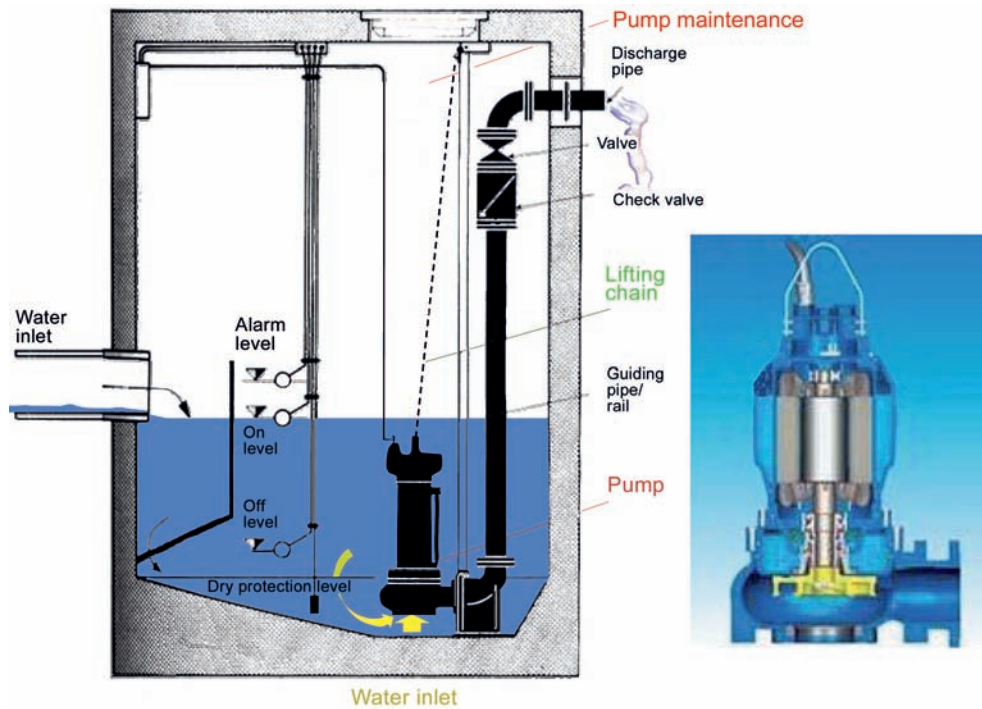

Figure 10. Submersible pump

### 1.3.2 Screw (Archimedes) pump

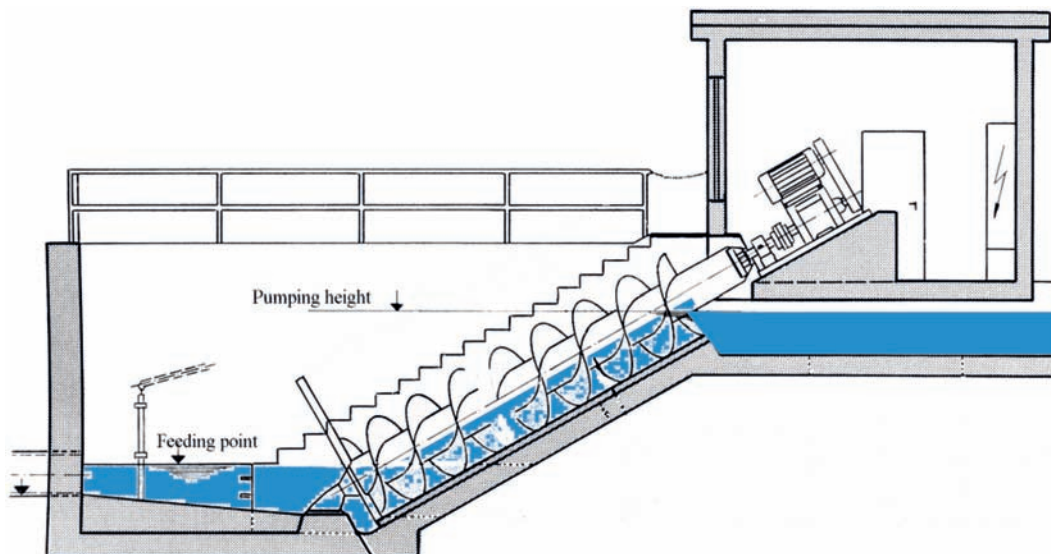

Figure 11. Schematic view of an Archimedes-type lifting pump



### 1.4. Fine screening

Fine screening should drastically reduce the amount of fine suspended solids. The figures below show rotary-drum screens with outer and inner flow.

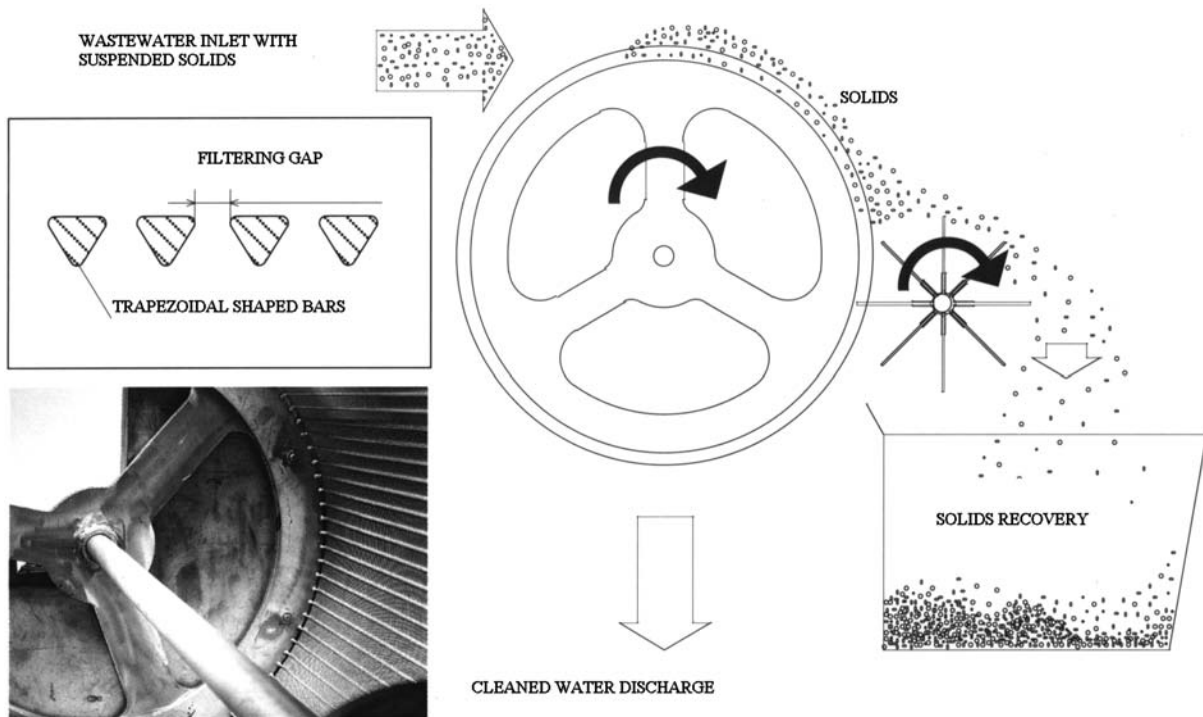

Figure 12. Rotary-drum (Konica) screen, outer flow

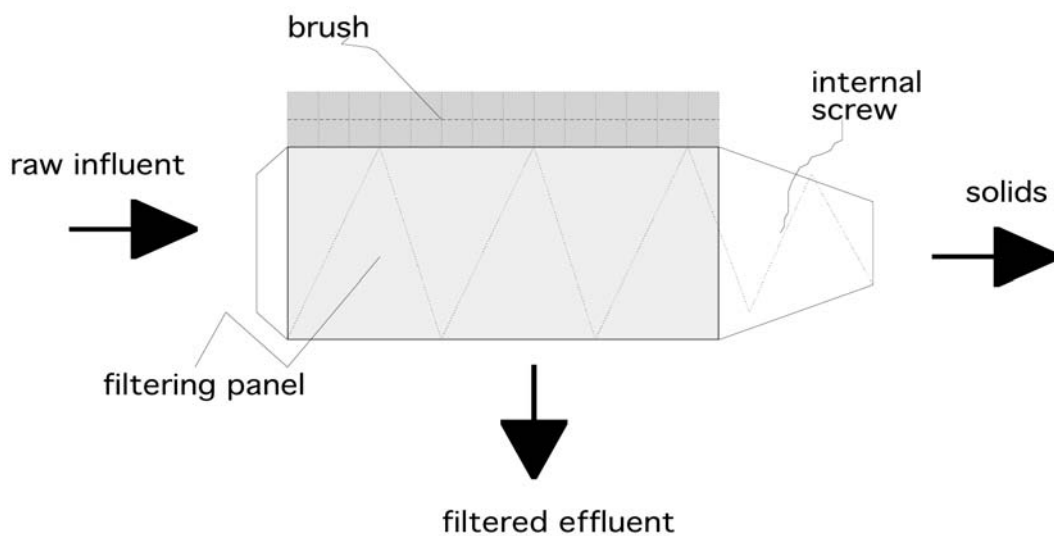

Figure 13. Rotary-drum fine screen, inner flow

### 1.5 Equalization – homogenization – sulphide oxidation

The main aims here are:

- homogenization of the effluent (quantity and quality); and
- sulphide elimination, mostly by catalytic oxidation.

It is very important to keep all particulate matters in suspension, i.e., to avoid settling of solids. This is achieved by using mixing-cum-aeration devices such as diffused-air systems (preferred), Venturi ejectors, and fixed or floating aerators (lately avoided due to lower efficiency and the problem of aerosols). In practice, to play it safe, the volume of the equalization tank corresponds to the total daily effluent discharge.

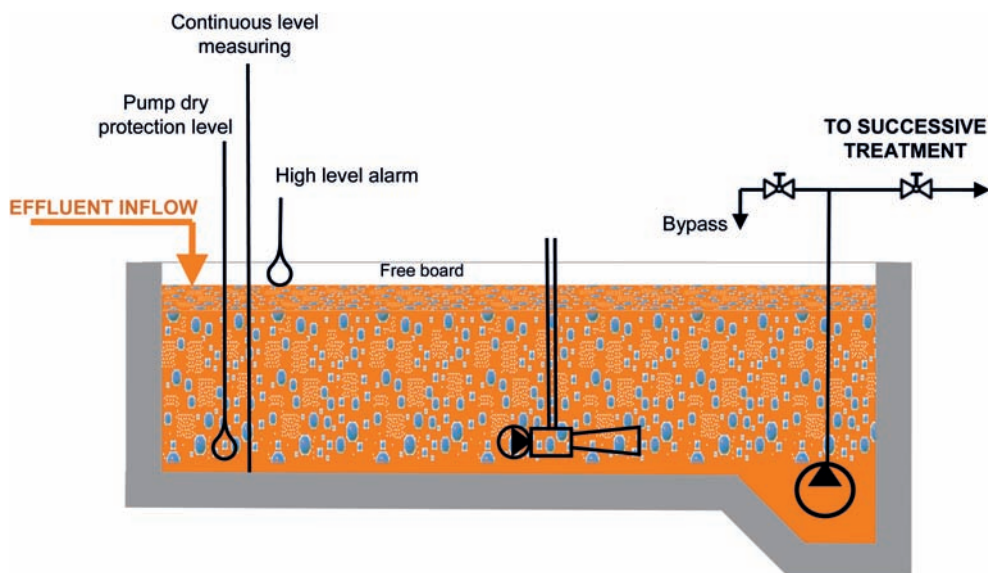

Figure 14. Schematic view of an equalization, homogenization tank

Approximately 1 kg of  $O_2$  is needed to oxidize 1 kg of  $S^{2-}$  to thiosulphate, whereas the oxygen transfer efficiency is about 1.5 kg  $O_2$ /kWh (simplified approximation: 1 kg  $S^{2-}$  = 1 kg  $O_2$  = 1kWh). Again, in practice, attention is focused on the energy required to keep the solids in suspension (some 50 W/m<sup>3</sup>), which is then sufficient for sulphide oxidation; the amount of catalyst,  $MnSO_4 \cdot 4 H_2O$ , industrial purity, is about 20 g per cubic meter of tank capacity.

Whichever the mixing/aeration system chosen, it is necessary to be possible to remove the mixing device without stopping the treatment process. The inlet and the outlet of the equalization tank should be as far away from each other as possible to allow proper mixing (and no short-circuiting).

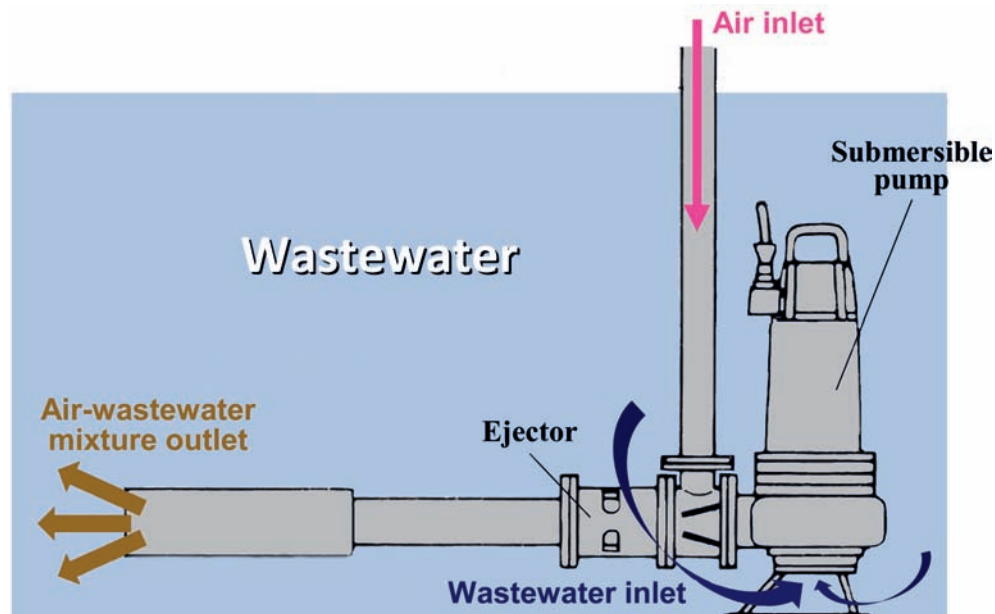

Figure 15. Venturi-type ejector often installed for mixing and aeration in the homogenization tank

A typical equalization tank will have transfer pumps for equalized effluent. The capacity of the pumps is based on tank capacity, transfer time and head. One pump of cast iron with inside parts of stainless steel and one stand-by pump are sufficient unless effluent volume is very high (say 1,500 m<sup>3</sup>/d or more). The pumping line(s) are also a good place to set an electro-magnetic flow meter.

### 1.6 Chemical treatment (coagulation, flocculation)

Chemicals are added in order to improve and accelerate the settling of suspended solids, especially of fine and colloidal matter.

In wastewater treatment operations, the processes of coagulation and flocculation are employed to separate suspended solids from water. These terms are often used interchangeably, or the single term – be it “coagulation” or “flocculation” – is used to describe both; sometimes “flocculation” is understood as the second stage of “coagulation”. In fact, they are two distinct processes usually carried out in sequence as a combination of physical and chemical procedures. Finely dispersed solids (colloids) suspended in wastewater are stabilized by negative electric charges on their surfaces, causing them to repel each other. Since this prevents these charged particles from colliding to form larger masses, called flocs, they do not settle.

Coagulation is the destabilization of colloids by neutralizing the forces that keep them apart. Cationic coagulants provide positive electric charges to reduce the negative charge (zeta potential) of the colloids. As a result, the particles collide to form larger particles (flocs). Rapid mixing is required to disperse the coagulant throughout the liquid. Care must be taken not to overdose the coagulants as this can cause a complete charge reversal and thus re-stabilize the colloid complex.

Flocculation is the action of polymers to form bridges between flocs and bind particles into large agglomerates or clumps. In this process it is essential that the flocculating agent be added by slow and gentle mixing to allow for contact between the small flocs and to agglomerate them into larger particles. The newly formed agglomerated particles are quite fragile and can be broken apart by shear forces during mixing. Care must also be taken not to overdose the polymer as doing so will cause settling/clarification problems.

Once suspended particles are flocculated into larger particles, they can usually be removed from the liquid by sedimentation, filtration, straining or floatation. The flocculation reaction not only increases the size of floc particles in order to settle them faster, but also affects the physical nature of flocs making them less gelatinous and thereby easier to dewater.

The inorganic coagulants are compounds that break colloidal suspensions and help floc forming. The most frequently used coagulants in tannery effluent treatment are:

- alum: industrial aluminium sulphate  $\text{Al}_2(\text{SO}_4)_3 \cdot 18\text{H}_2\text{O}$
- iron sulphate: industrial  $\text{FeSO}_4 \cdot 7\text{H}_2\text{O}$
- iron chloride: industrial  $\text{FeCl}_3 \cdot 6\text{H}_2\text{O}$
- lime: industrial calcium hydroxide  $\text{Ca}(\text{OH})_2$

Coagulant aid – flocculants – are water-soluble organic (anionic) polyelectrolytes that support agglomeration of colloidal and very fine suspended matter thus enhancing the impact of coagulation.

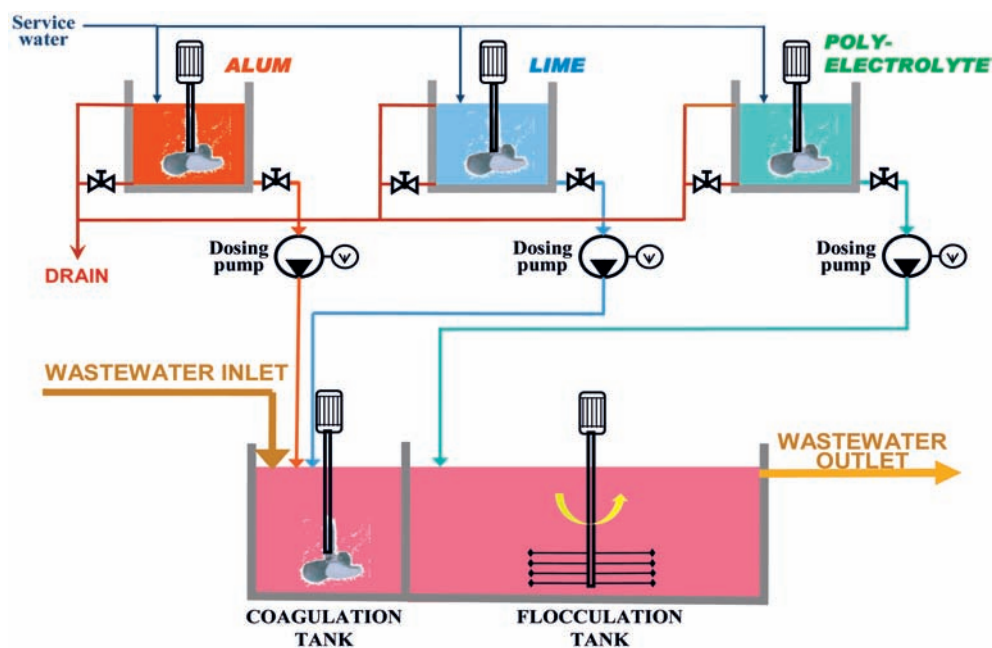
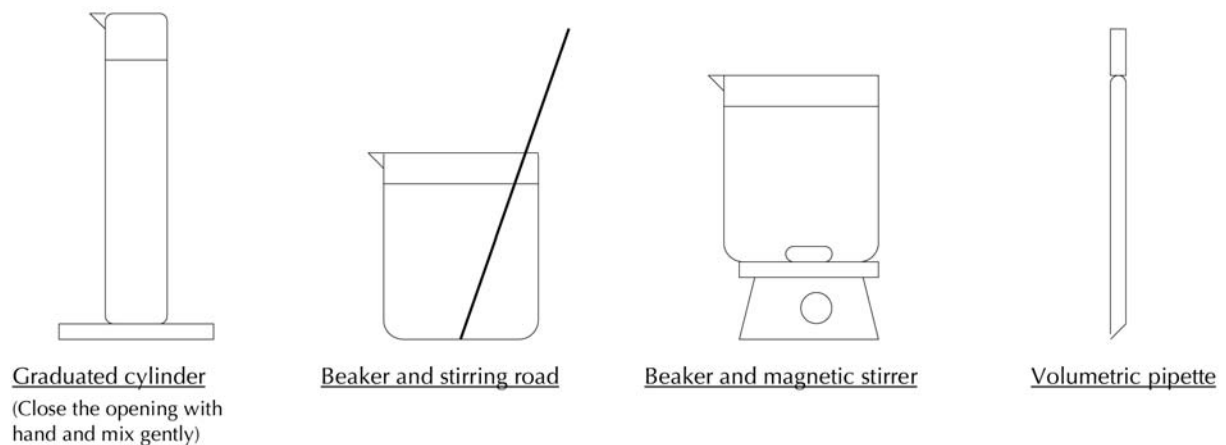

Figure 16. Schematic view of the coagulation and flocculation system

For optimal results, appropriate dosing is essential; it should not be overlooked that, in addition to costs, these chemicals also influence not only pH (acidification) but also TDS. On-the-spot investigation – jar tests using either sophisticated apparatus or simple tools (shown below) – is a must.



**Figure 17. Some simple laboratory utensils**

Chemicals (pre)dissolved in small tanks with stirrers are usually added in the flash mixers – special “boxes” for rapid mixing placed before the primary settling tank. The contact time in the flash mixer is about 5 minutes for coagulation and some 20 minutes for flocculation; in the latter case, slow mixing to avoid floc shearing is essential. Hence, for example, if the capacity of the equalized effluent transfer pump is  $60 \text{ m}^3/\text{h}$ , the usable volume of the coagulation and flocculation tank respectively should be  $60 \cdot 1/12 = 5 \text{ m}^3$  and  $60 \cdot 1/3 = 20 \text{ m}^3$ .

Ideally, two tanks should be available for the preparation of each chemical – one for solution preparation, the other for feeding the solution to the effluent. By having two tanks, levels of chemical dosing can be better controlled. The feeding of chemicals is done by dosing pumps.



**Photo 1. Coagulant/flocculant dosing station**

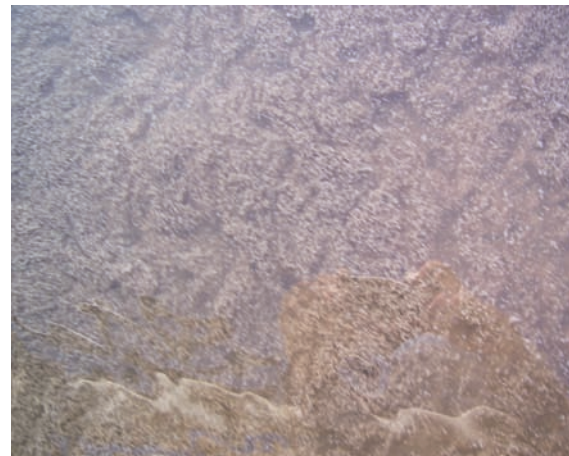

**Photo 2. “Flocs” after coagulation-flocculation**

## 1.7 Settling – primary sedimentation

The main objective at this stage is the removal of suspended solids; however, various constituents such as fats, waxes, mineral oils, floating non-fatty materials, etc. (“grease”), not already removed in the grit-and-oil chamber (usually positioned between screening and equalization), are also separated here.

Primary settling tanks (clarifiers) are either circular (more commonly used) or rectangular with continuous grease (scum) removal at the top and sludge removal at the bottom. The key design parameters are:

- detention time – usually 1 to 2 hours (vertical clarifiers of the Dortmund type);
- surface hydraulic loading, expressed in  $\text{m}^3/\text{m}^2$  of tank surface per hour or  $\text{m}/\text{h}$ , typically 1 to 2  $\text{m}^3/\text{m}^2$  per hour;
- surface solids rate, expressed in  $\text{kg}/\text{m}^2$  and indicating the quantity of SS crossing the surface area of the tank over a certain time span (hour, day).

The surface solids rate is most frequently used in the design of sludge thickeners but, due to the quantity (4-6 g/l) and flocculent nature of tannery effluent solids, it is useful in controlling the primary sedimentation as well. Circular tanks are generally preferred as recirculation is easier. A mechanical device (scraper) is necessary in larger settling tanks.

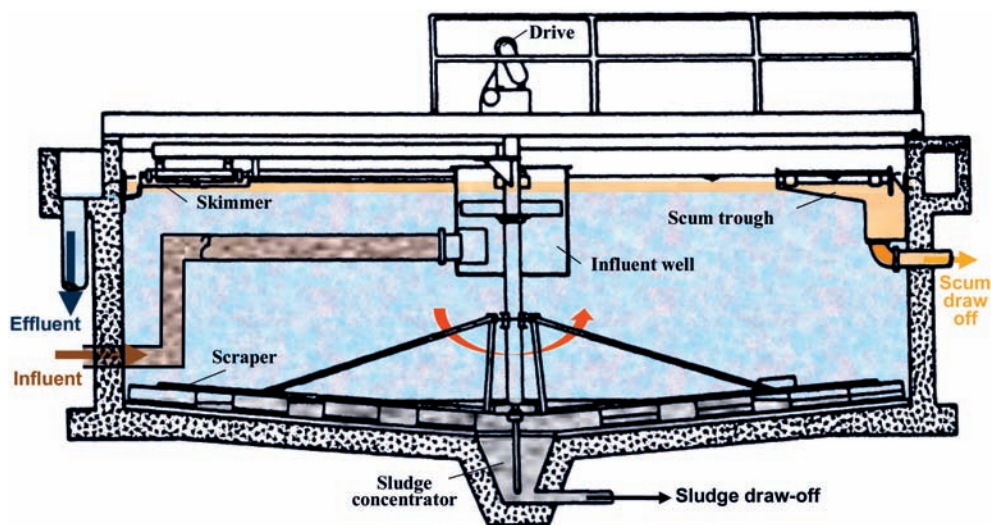

Figure 18. Cross section of a typical circular sedimentation tank

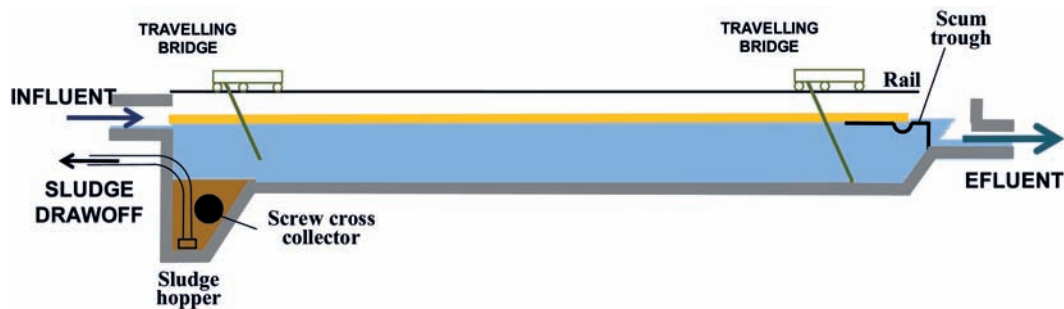

Figure 19. Cross section of a rectangular sedimentation tank with travelling bridge shown in two positions



Photo 3. Sedimentation tank (empty)



Photo 4. Sedimentation tank in operation

In some cases, mainly due to space shortage, solids are removed by flotation, usually by the dissolved-air flotation (DAF) system.

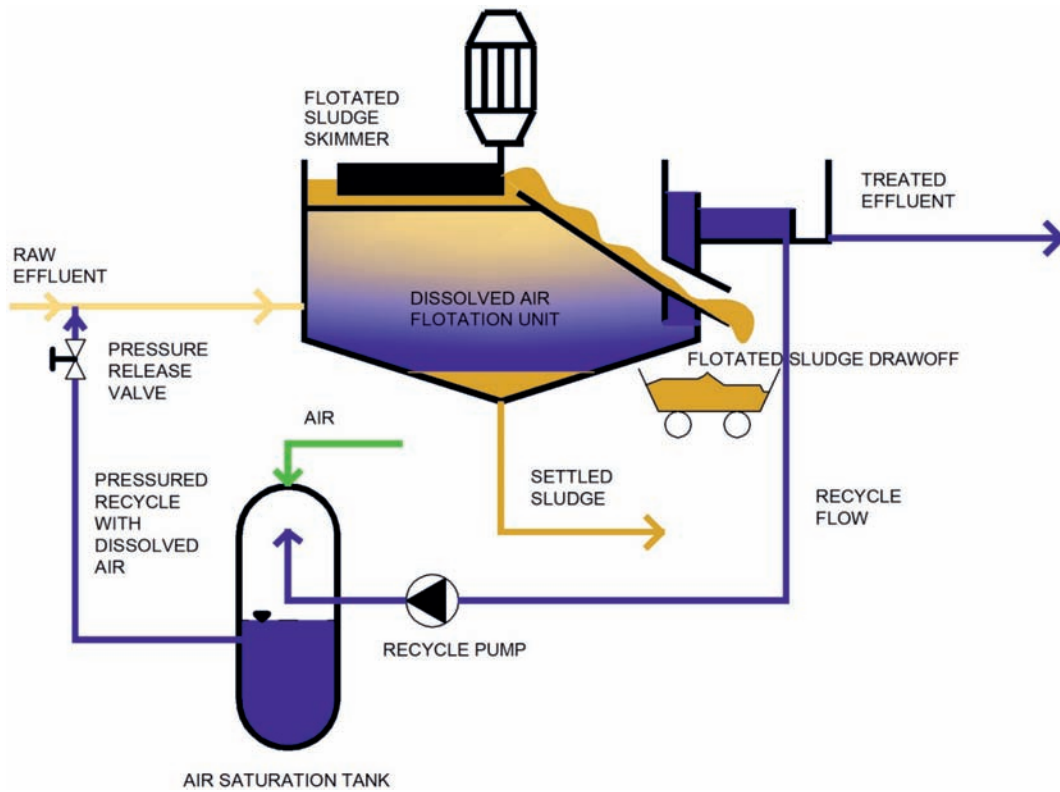

Figure 20. Schematic view of a dissolved-air flotation (DAF) unit

### 1.8 Sludge dewatering

The sludge drawn from the bottom of the tank is in the form of slurry with a dry-solid (DS) content of only 2-4%. For its evacuation, special pumps – usually of the Mohno type – are used.

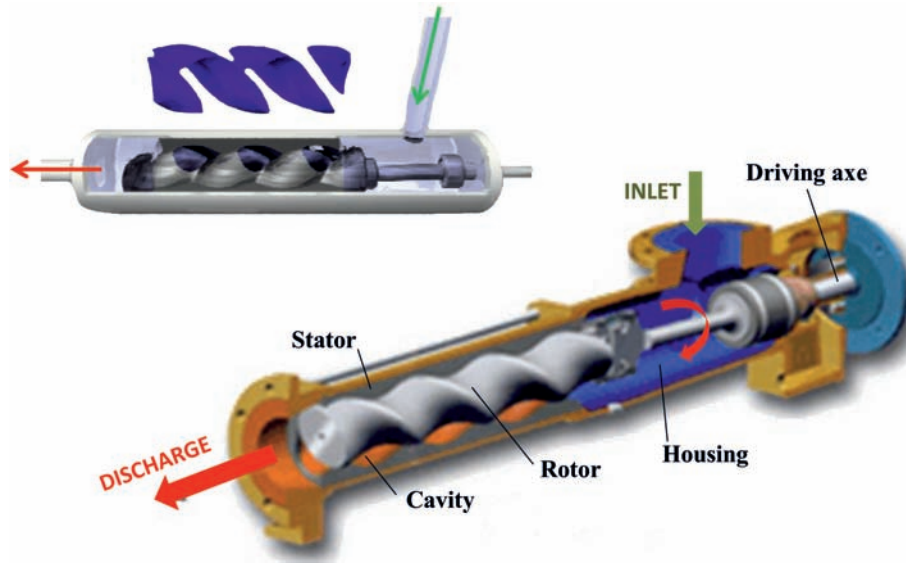

Figure 21. Cross section of a progressing cavity pump for sludge transfer

For further handling and disposal of sludge, it is necessary to reduce drastically the water content. This is usually achieved by: (i) thickening in sludge thickeners (very much like circular clarifiers); (ii) mechanical dewatering in filter presses, belt-filter presses or decanters (centrifuges); (iii) natural drying in sludge-drying beds. In addition to power and chemical requirements, the key parameter for equipment selection is the achievable dry matter content in the dewatered sludge.

### 1.8.1 Sludge thickener

The construction of the sludge thickener is in practice identical with that of the sedimentator although in some cases the Dortmund type with self-desludging slopes is also used.

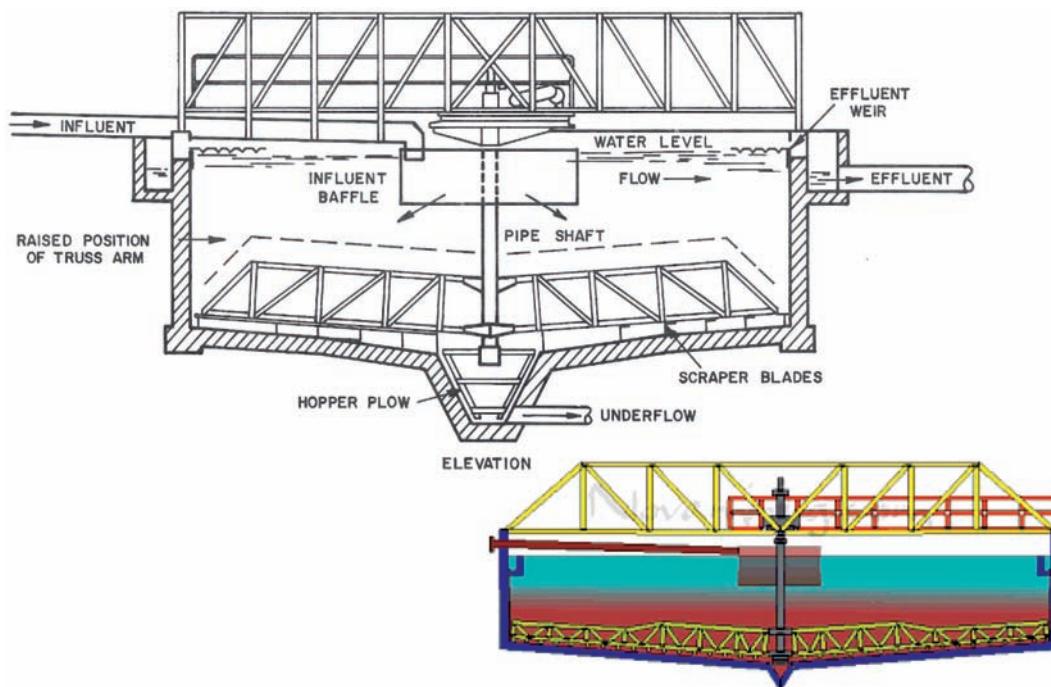

Figure 22. Cross section of a gravity thickener



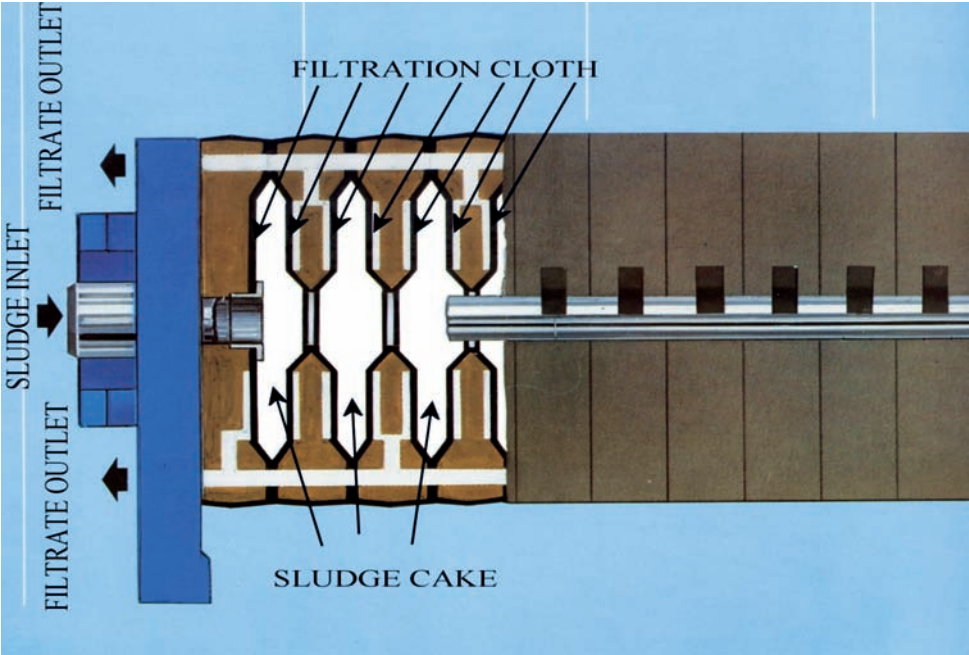

Figure 23. Cross section of a recessed-plate press for sludge dewatering



Photo 5. Recessed-plate filter press with container for dewatered sludge

### 1.8.2 Belt-filter press

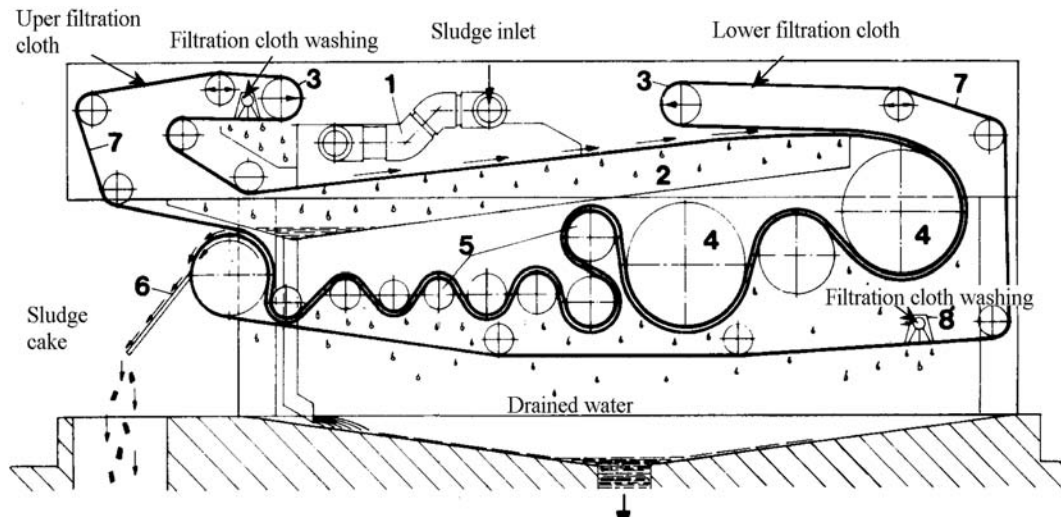

Figure 24. Cross section of a belt-type press for sludge dewatering

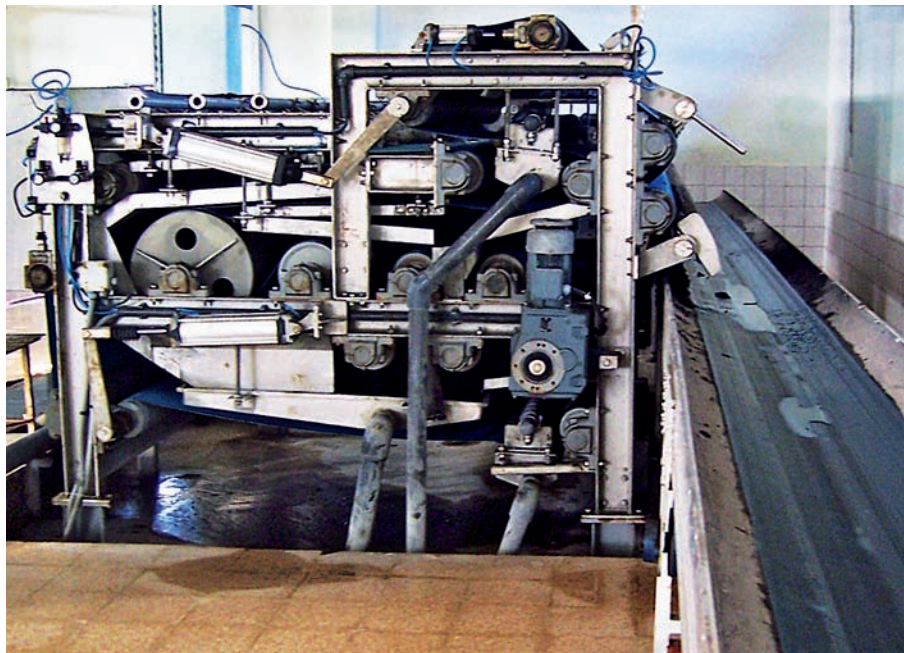

Photo 6. Belt press with transporter for dewatered sludge

### 1.8.3 Centrifuge

By increasing dewatering level, improving wear and tear resistance (especially in the case of sludge containing fine sand) as well as by lowering irritating noise, centrifuges have succeeded in conquering a lot of ground in the treatment of tannery effluents.

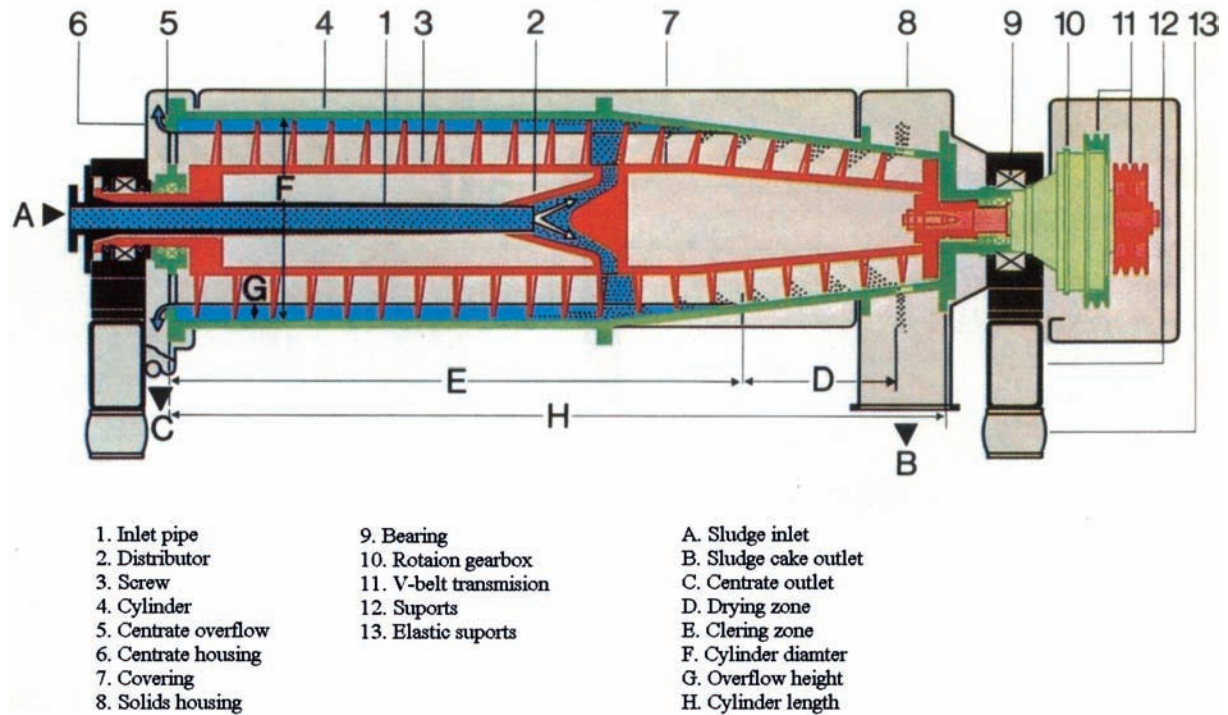

Figure 25. Cross section of a sludge dewatering centrifuge

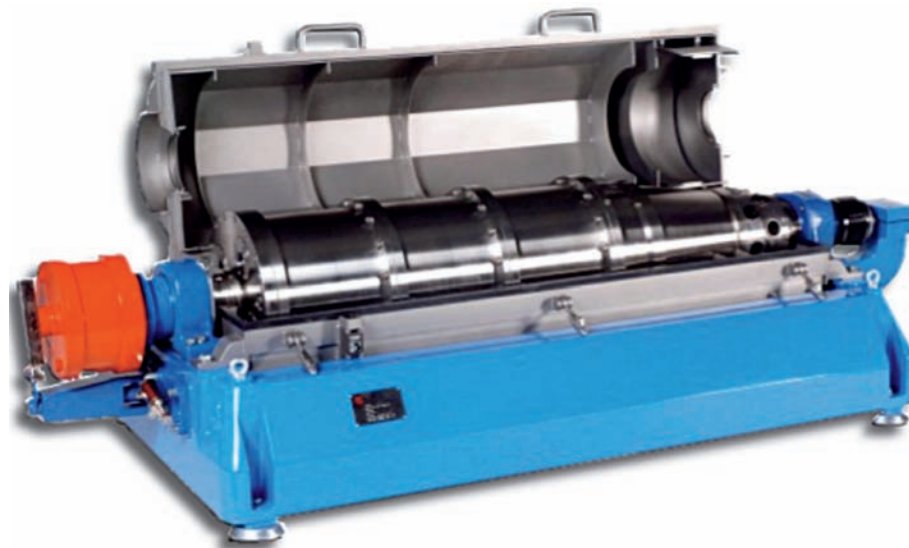

Photo 7. Sludge dewatering centrifuge (the lid is up for a better view)

Mechanical dewatering effects are nowadays from 30 to 40% DS, depending on initial concentration, chemical preconditioning and equipment make.

### 1.8.4 Sludge-drying beds

Easily constructed with locally available materials, drying beds were perceived as the best solution for tanneries in hot-climate developing countries. However, they require a lot of area, the output during rainy seasons drops considerably, there is the problem of malodour, they are not easy to clean and made ready for the next batch, etc. For these reasons, sludge-drying beds are still used mainly by small tanneries not close to residential areas and/or as fall-back units used during breakdowns of mechanical dewatering equipment.

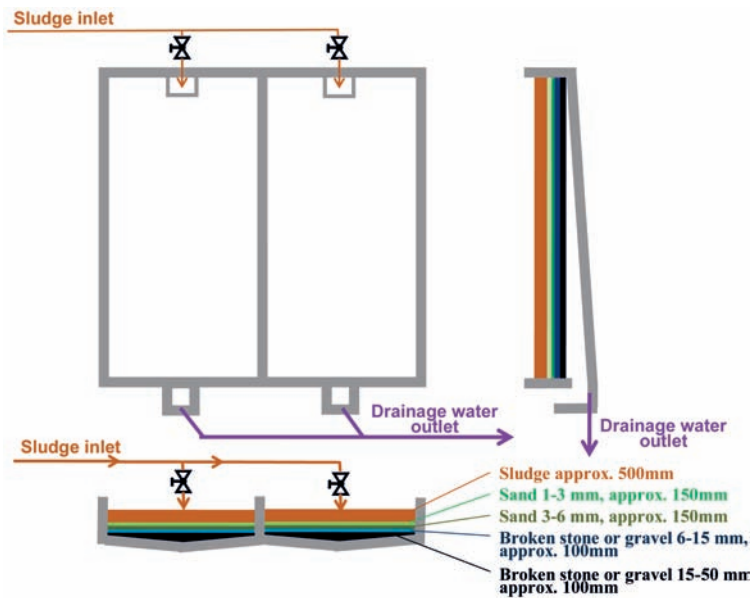

Figure 26. Schematic views of sludge-drying beds

The products of primary treatment are: (i) primary treated effluent – overflow from the primary settling tank – with only residual amounts of chrome and sulphide and significantly reduced BOD, COD and SS content; and (ii) dewatered sludge – with approximately 40% DS; its chrome content depends on the type and efficiency of the chrome management system applied.

For the fortunate tanneries coupled to the sewage system, on-site treatment ends here – the biological treatment takes place together with urban wastewater in large WWWs. Usually, industrial effluents are only a small fraction of the total volume so that the salinity (TDS) they bring along does not represent a problem.

| Parameter  | Physical-chemical |                    | Biological    |                    |
|--|-------------------|--------------------|---------------|--------------------|
|  | Reduction %       | Approx. value mg/l | Reduction * % | Approx. value mg/l |
| SS   | 80-90             | 300-600            | 95-98         | 20-50              |
| BOD <sub>5</sub>   | 50-65             | 750-1500           | 97-99         | 20-30              |
| COD  | 50-65             | 1500-3000          | 87-93         | 250-400            |
| TKN  | 40-50             | 250-300            | 60-           | 100-200            |
| Cr   | 92-97             | 5-10               | 99-99.5       | <1                 |
| S <sup>2-</sup>  | 80-90             | 10-20              | 99-99.5       | <1                 |
| TDS, mainly Cl <sup>-</sup> and (SO <sub>4</sub> ) <sup>2-</sup> | No reduction!     |                    |               |                    |

\* Approximately at the load level of 0.30 kg BOD<sub>5</sub>/kg MLSS, oxygen requirement of 2.0 kg O<sub>2</sub>/kg BOD<sub>5</sub> and MLSS 3300 g/m<sup>3</sup>

Table 4. Purification efficiency of treatment stages referred to raw effluent

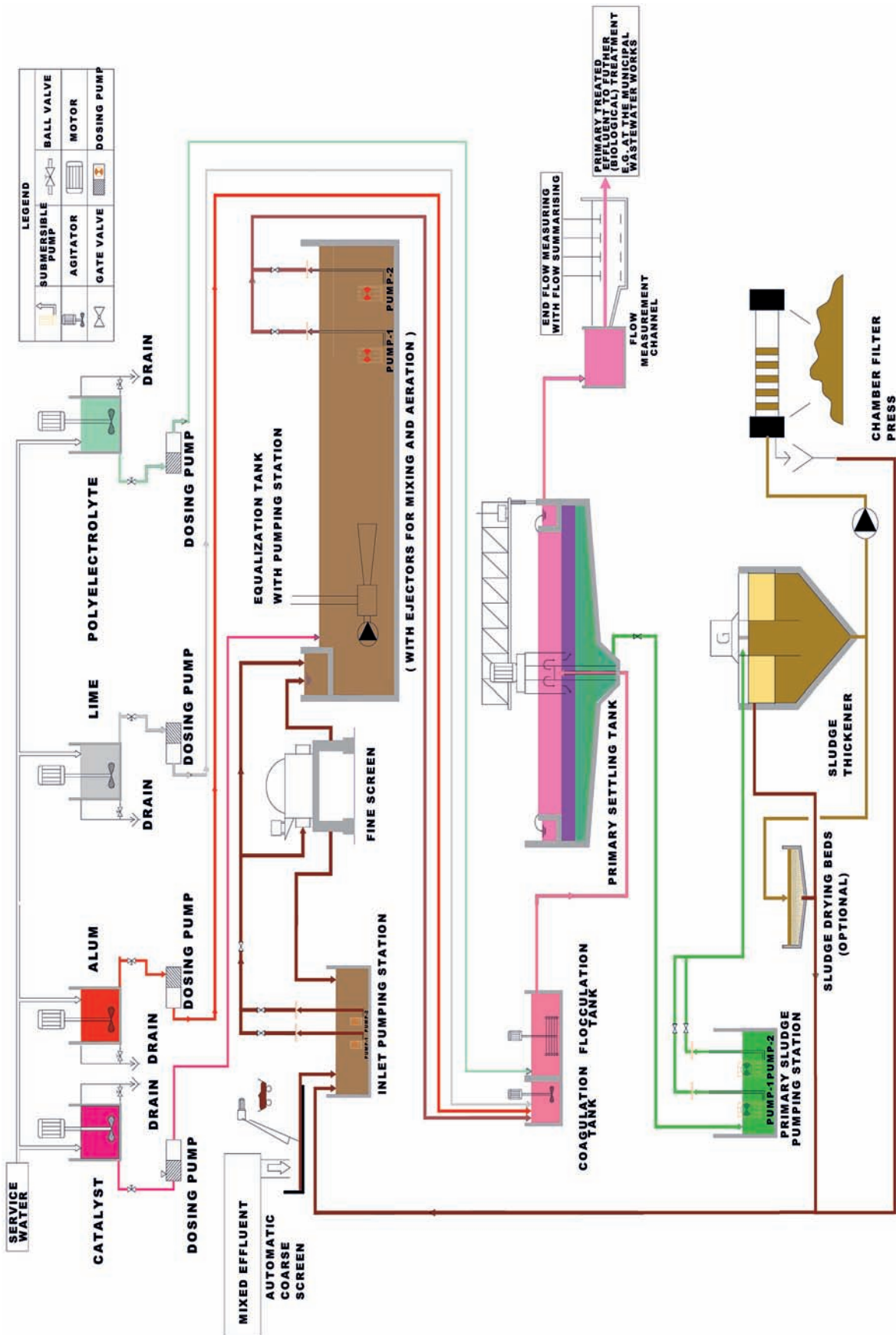

Figure 27. Simplified flowchart of the physical-chemical (primary) tannery effluent treatment

## 2. Biological (secondary) treatment

### 2.1 Objective and basic principles

The main objective at this stage is to further reduce the amount of organic (expressed as BOD and COD)<sup>3</sup> and other substances still present in the effluent after the primary treatment and thereby satisfy the standards/limits for discharge into surface waters (rivers, lakes).

The biological treatment duplicates processes that take place in nature, but under controlled conditions and, especially, at a highly accelerated pace; however, the efficiency of this treatment largely depends on the biodegradability of the polluting substrate, i.e., its inherent capacity to decompose by biological processes. The remaining suspended and colloidal solids are removed by flocculation and adsorption.

While biological treatment may be aerobic, facultative or anaerobic (or some combination thereof), in practice, almost only aerobic systems are used; exceptionally, in countries with a hot climate and where a lot of land is available, facultative (preferably aerated/facultative) lagoons are also used.

Due to the inherent characteristics of tannery effluents, primarily their sulphide/sulphate content, in practice, anaerobic treatment is used only in sludge digestion.

Among many variations of the aerobic process, the most widely used method is (complete-mix) activated sludge treatment with extended aeration; despite some very interesting features, membrane bioreactors (MBRs) have not made significant inroads in the tanning sector.

The activated sludge process is an aerobic, biological process, which uses the metabolism of micro-organisms to remove substances causing oxygen demand. The qualitative biochemical reaction taking place in the organic matter stabilization process can be summarized in the following manner:

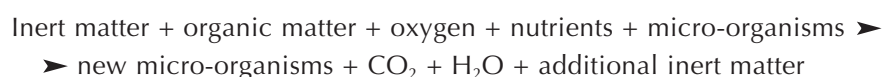

Simply said, we stimulate micro-organisms to convert (eat and digest) harmful, oxygen-demanding organic compounds into an environmentally more acceptable form (micro-organisms) and low-energy, stable compounds like water and carbon dioxide.

The microbial community that does that job comprises various species of bacteria, fungi, protozoa, sometimes rotifers (multicellular animals only found in very stable activated sludge with long retention times), even nematodes, the composition of the population depending on a plethora of factors.

<sup>3</sup> Let us recall that BOD is defined as the quantity of oxygen required during the stabilization of decomposable organic and oxidizable inorganic matter by aerobic biological action under standard conditions, usually over only five days instead of 20. The manometric method is even faster but less accurate and reliable.

COD is the quantity of oxygen consumed for the total oxidation of the oxidizable matter (organic and inorganic) with dichromate as the oxidizing agent. The COD is always greater than its BOD.

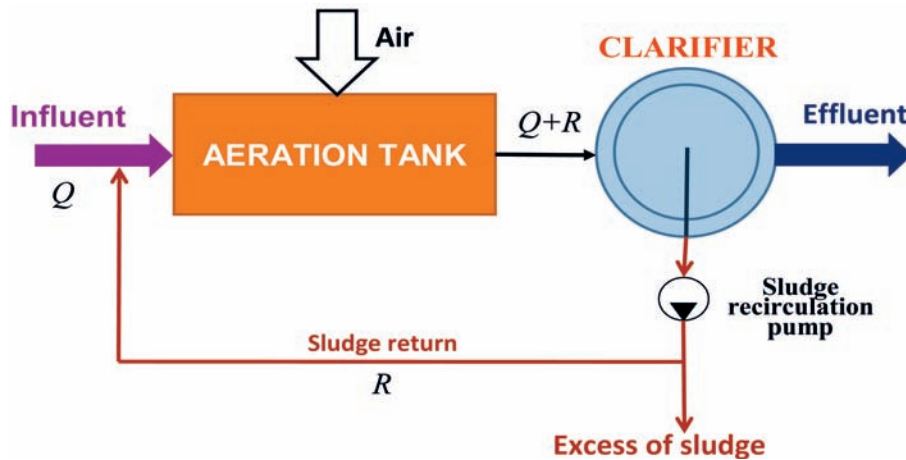

Figure 28. A simplified flow diagram of the activated sludge process

Generally, the biological stage is the most complex part of the overall effluent treatment process, with highest investment and operational costs, its day-to-day running requiring considerable skills and experience.

## 2.2 Main operational parameters

The main operational parameters – expressions important to understanding the process – are:

- **Total influent volume, Q:** volume of treated effluent ( $\text{m}^3/\text{day}$ )
- **Tank volume, V:** aeration tank volume ( $\text{m}^3$ )
- **Organic loading, F:** total  $\text{BOD}_5$  applied ( $\text{kg}/\text{day}$ )  
 $F = (f \times Q)/1,000$   
 where  $f$  is the  $\text{BOD}_5$  of the influent ( $\text{mg}/\text{l}$ )
- **Mixed liquor suspended solids, M:**  
 $M = (\text{MLSS} \times V)/1000$   
 where MLSS is the concentration of SS in mixed liquor in the aeration tank ( $\text{mg}/\text{l}$ )
- **Loading factor, F/M:**  $\text{BOD}_5$  kg per day per kg of mixed liquor suspended solids (MLSS) in the aeration tank ( $\text{mg}/\text{l}$ )
- **Hydraulic retention time, T:**  
 $T = (V/Q) \times 24$   
 where  $V$  is aeration tank volume ( $\text{m}^3$ )

A uniform inlet flow over the entire day provides optimum conditions for absorbing the effect of possible peaks of organic load or toxic substances (shock loads) and enhancing the efficiency of secondary sedimentation.

The  $\text{BOD}$  here is in practice taken to represent the amount of food provided to the micro-organisms contained in the system. Due to the difficulty of obtaining reliable  $\text{BOD}_5$  values,  $\text{COD}$  is sometimes used.

Hydraulic retention time is actually the average time (in hours) the influent spends passing through the aeration tank; the extended aeration process, typical for tannery effluents, is usually longer than 24 hours.

Extended aeration plants are characterized by the introduction of wastewater directly into the reactor basin, long aeration, high sludge return ratio, low sludge wastage and high MLSS: the F/M (kg BOD/kg MLSS per day) ratio is only  $\leq 0.05 - 0.1$  in contrast to the conventional (0.15-0.4) or high-load type (0.4-1.0).

| Process           | F/M ratio | Kg O <sub>2</sub> /kg BOD |
|-------------------|-----------|---------------------------|
| Extended aeration | 0.1       | 2.0                       |
| Conventional      | 0.4       | 1.2                       |
| High load         | 1.0       | 0.8                       |

The F/M, the food to biomass (floc) ratio is a parameter crucial for operational conditions and the performance of the biological process; regrettably, it cannot be determined quickly, on-the-spot.

### 2.3 Other operational parameters

Quite important are also parameters like the sludge age expressed as the mean cell-residence time (MCRT), generally not less than 20 days, and the return activated sludge (RAS) – the volume of settled biological sludge recycled to the aeration tank as a percentage of the influent volume Q; in the extended aeration process, it is about 80-100%.

The following parameters are, in particular, regularly monitored:

Dissolved oxygen (DO) is the content of molecular oxygen in the aeration tank (mg/l); it is one of the most important factors determining the efficiency/performance of wastewater biological treatment. Extended aeration units are usually operated in such a way as to keep the DO of the mixed liquor at about 2 mg/l.

pH. The optimum pH range for aerobic processes is between 7.0 and 7.5 with an effective process range of 6-9. In alkaline wastes, the reaction with CO<sub>2</sub> produced by respiration neutralizes the excess alkali, making addition of acid unnecessary. Adjustment with lime or other alkali becomes necessary only if pH drops below 6.

Temperature affects the metabolic and growth rates of the organisms responsible for the biological processes. Generally, as the temperature is raised 10-30°C, the growth rate increases. However, higher temperature negatively affects the water solubility of oxygen and the oxygen transfer rate (solubility decreases with a rise in temperature). For this reason, an increase of the aeration rate becomes necessary during the hot season.

Nutrients. The nutritional balance of an aerobic system is primarily based upon satisfying the requirements of the cell structure produced by the removal of BOD from waste. Efficient and successful biological oxidation requires a minimal quantity of nitrogen and phosphorus. A BOD : N : P ratio of 100 : 5 : 1 in the waste usually insures adequate nutrition. Tannery effluent is very rich in nitrogen and sometimes poor in phosphorus.



Sludge volume index (SVI) is the volume occupied by 1 g of activated sludge after settling the aerated mixed liquor in a 1,000 ml graduated cylinder or Imhoff cone for 30 minutes. It provides a good indication of sludge compacting characteristics, very helpful in controlling the activated sludge process, especially in determining return sludge pumping requirements to maintain different mixed-liquor concentrations.

$$SVI = \frac{\text{settled sludge volume} \cdot 1,000}{\text{suspended solids}} \left[ \frac{\text{ml/l}}{\text{ml/l}} \right]$$

Well settleable and mineralized sludges have SVI <100.

## 2.4 Aeration devices

Water (effluent) aeration is important business that employs a wide range of equipment. In addition to cost, reliability, etc., the key criterion is the amount of air (oxygen) transfer per kW installed. Here is one – rather arbitrary – classification:

### a. Surface aerators

Radial flow, low speed, 20-60 rpm

Axial flow, high speed, 300-1200 rpm

Brush rotor (oxidation ditch)

### b. Submerged turbines

### c. Diffusers

Bubblers – porous and non-porous diffusers

Tubular

Jets (developed from Venturi ejectors)

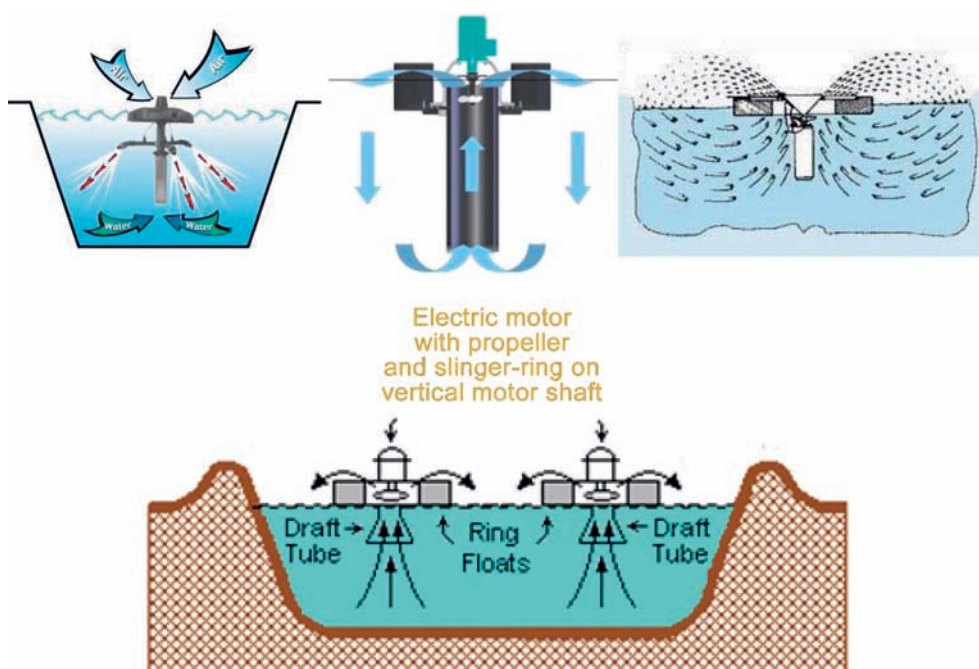

Figure 29. Surface (floating) aerators

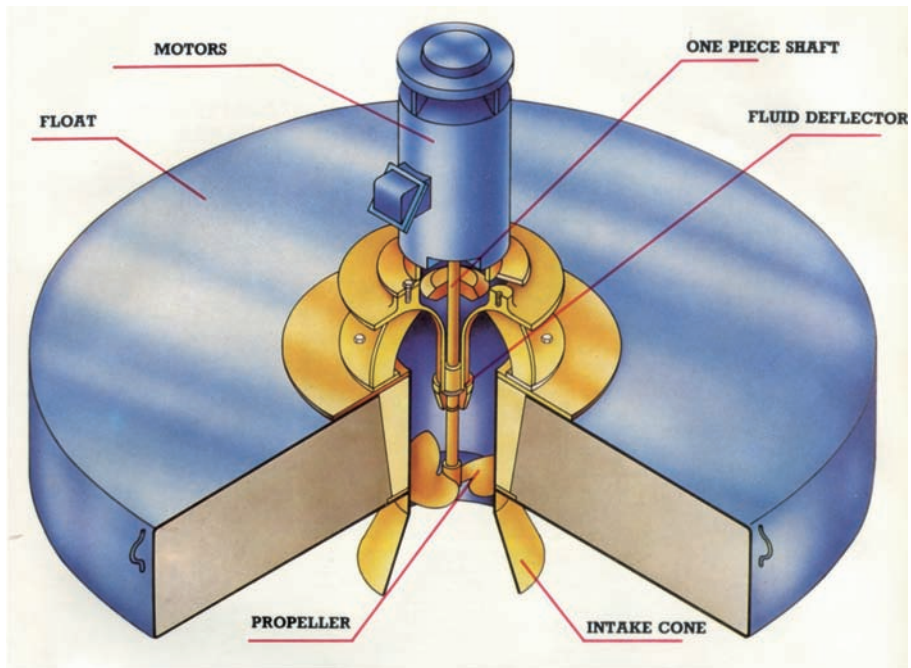

Figure 30. Cross section of floating aerator



Photo 8. Surface aerators

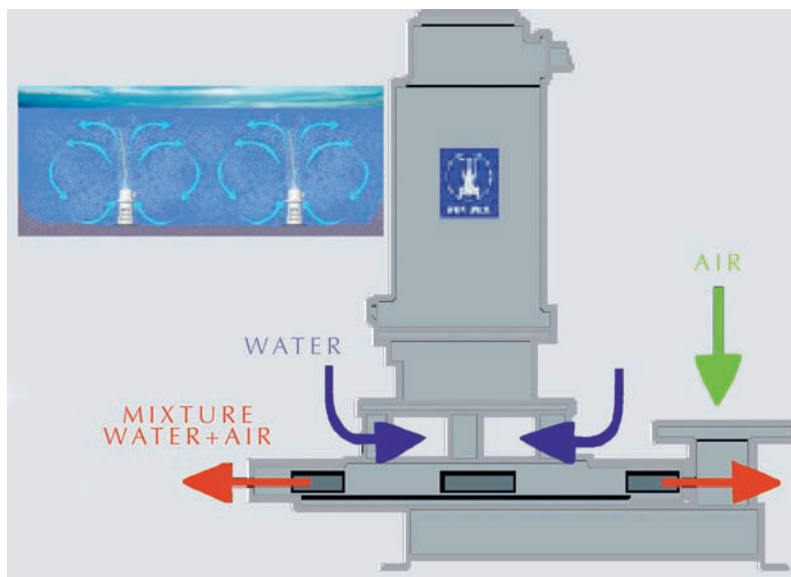

Figure 31. Forced-air, submersed turbine aerator

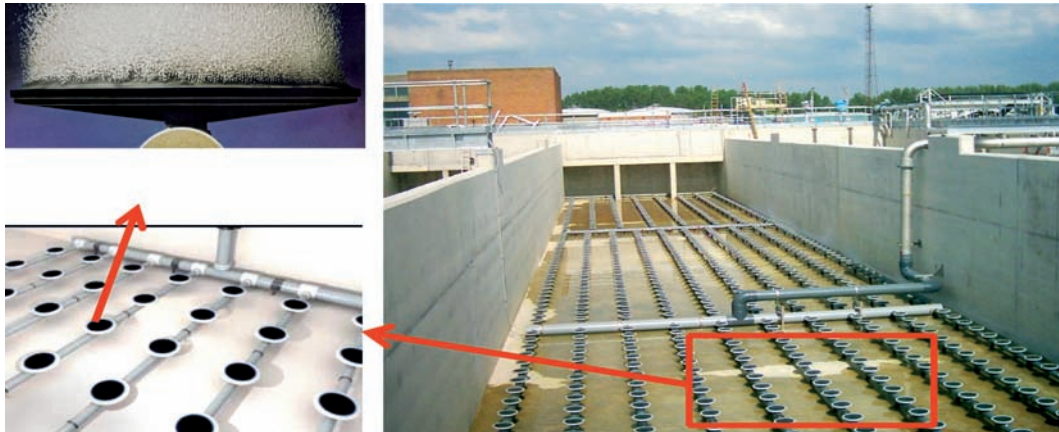

Photo 9. Bottom air diffuser grid with one section and fine-bubble dome diffuser

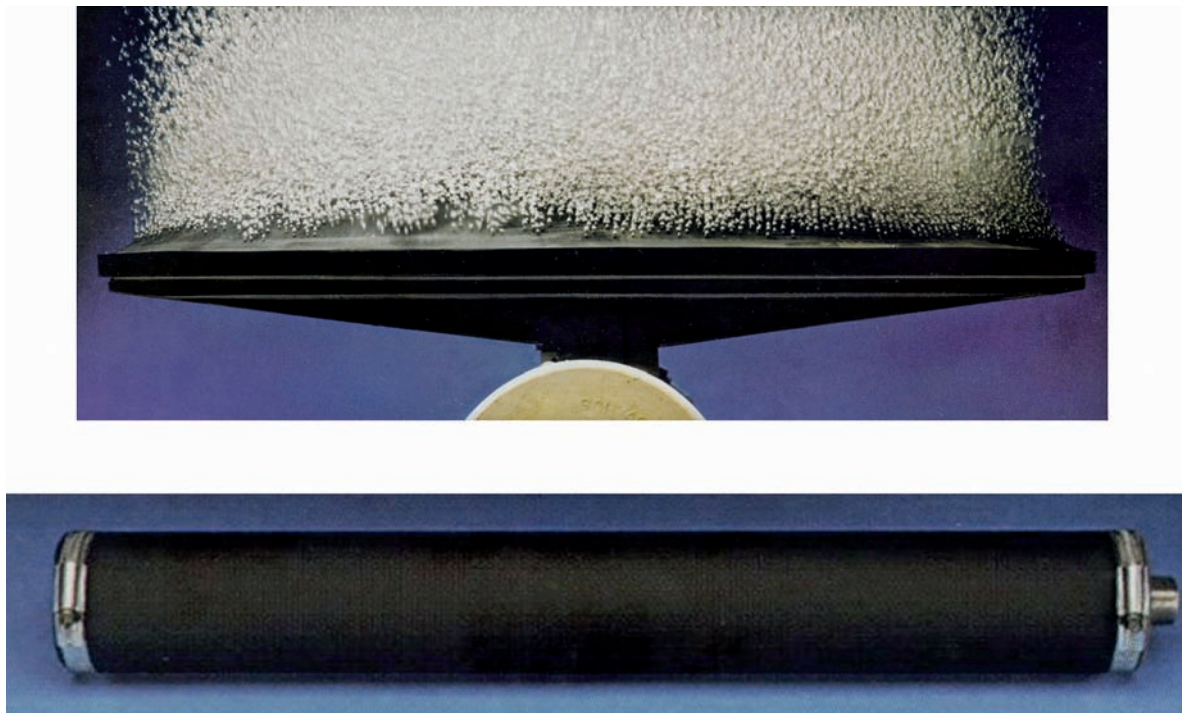

Photo 10. Fine-bubble difusers, dome and tubular type

## 2.5 Aeration basins, oxidation ditch

The possibly best biological treatment of tannery effluents is the oxidation ditch (OD) and its various derivatives – a circular aeration basin (racetrack-shaped), with rotary-brush or vertical-rotor (carrousel) aerators that extend across the width of the ditch.

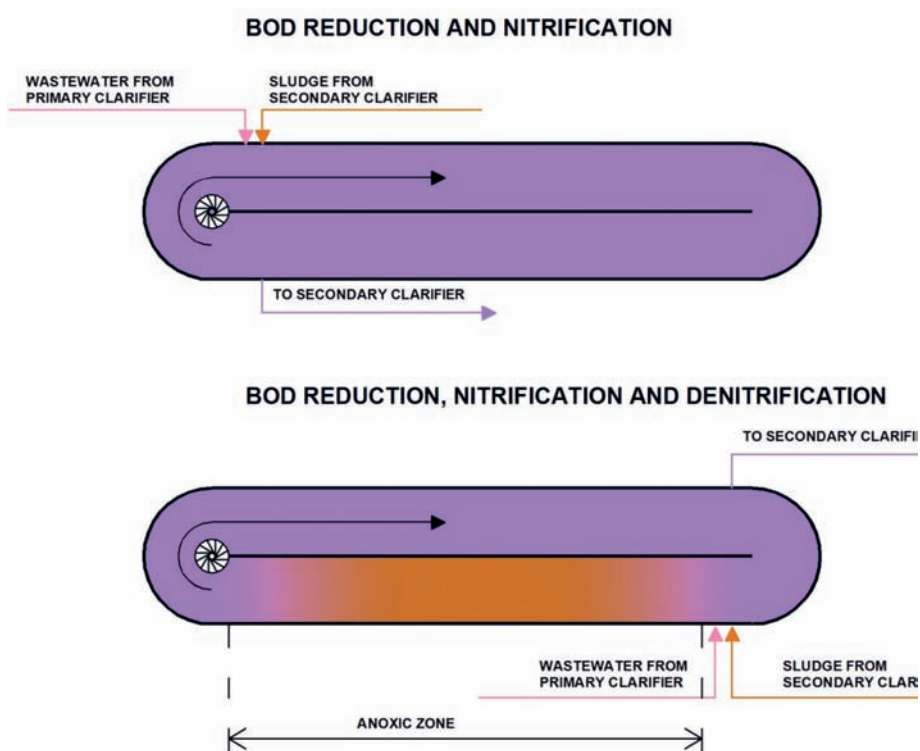

Figure 32. Schematic diagram of oxidation ditches with BOD removal, nitrification and denitrification

In addition to its simple construction and easy maintenance, the main advantage of the OD is its resilience to variations in flow, pollution load, including shock loads. It is even possible to combine several ovals and maintain different aeration regimes suitable for nitrification and denitrification.



Photo 11. Submersed turbine aerators in oxidation ditch



**Photo 12. Oxidation ditch in operation**

## 2.6 Secondary sedimentators

Their design is very similar to those of primary sedimentators, but the operational conditions are different. Also, the (excess – wastage) sludge evacuated at the tank bottom is normally bulkier and more difficult to dewater.

Surface hydraulic loading – or surface overflow rate (SOR) – is the vertical velocity of the influent in the secondary sedimentation tank ( $\text{m}^3/\text{m}^2$  of tank surface per hour, m/h).

SOR of approximately  $0.5 \text{ m}^3/\text{m}^2$  per hour is generally used for secondary sedimentation of tannery effluents, i.e., less than for primary clarifiers.

Surface solid rate (SSR) is the quantity per hour of MLSS (kg) crossing the surface area of the secondary sedimentation tank ( $\text{kg}/\text{m}^2$  of tank surface per hour) (see primary sedimentation).

SSR values between  $2.0$  and  $3.0 \text{ kg}/\text{m}^2$  per hour are generally used for secondary sedimentation of tannery effluents.

The overflow from the secondary clarifiers represents the fully treated effluent usually fit for discharge into a final recipient.

In order to satisfy the legal limits for nitrogen (ammonia and TKN), very often nitrification and denitrification stages need to be introduced into the biological system. Nitrification requires extensive aeration as well as a low F : M ratio ( $< 0,1$ ) to facilitate conversion of nitrogen containing organic matter into nitrate and nitrite salts. During the denitrification stage, which for operational reasons can take place either at the very beginning or at the end of the biological treatment, these salts are converted under anoxic conditions into neutral nitrogen gas ( $\text{N}_2$ ) and water.

## 2.7 Anaerobic biological treatment

As mentioned earlier, despite its high performance, comparatively lower costs and wide use in other industries, anaerobic treatment has failed to make inroads in the tanning industry. The main reason is that tannery effluent treatment leads to the development of a highly toxic, corrosive and flammable gas, hydrogen sulphide (H<sub>2</sub>S); difficulties and risks in dealing with this gas prevail over other, positive features of anaerobic treatment.

## 3. Advanced (tertiary) treatment

In certain cases, despite extensive physical-chemical and biological treatment in a well designed ETP, the quality of the final effluent does not meet the promulgated discharge limits. The usual culprit is the recalcitrant COD, i.e., compounds that the micro-organisms present in the floc are unable to decompose.

In such cases, it is necessary to resort to additional, usually more sophisticated and rather expensive treatments such as mineralization of organic compounds by oxidation with H<sub>2</sub>O<sub>2</sub> in the presence of ferrous sulphate (Fenton process and its derivatives). Ozonation is sometimes included not so much to kill potentially harmful micro-organisms but to destroy part of the residual COD.

## 4. Sludge handling

### 4.1 Mechanical sludge dewatering

The main purpose of sludge dewatering is not only to reduce the volume and weight of material to be transported but also to attain the dry matter content required for disposal at landfills.

The equipment used for this purpose – recessed-plate filters, belt presses and decanter centrifuges – was already described earlier. Here is a short comparative overview of the main characteristics and efficiencies of the various systems as well as changes in DS content throughout the treatment process.

| Equipment                       | Decanter                | Belt press              | Plate-filter press             |
|---------------------------------|-------------------------|-------------------------|--------------------------------|
| Way of operation                | continuous              | continuous              | batch                          |
| Sludge conditioning             | required <sup>(1)</sup> | required <sup>(1)</sup> | not required <sup>(2)</sup>    |
| Washing water                   | not required            | required <sup>(3)</sup> | not required <sup>(4)</sup>    |
| Labour                          | only supervision        | only supervision        | required during cake discharge |
| Sensitive to sludge variability | very sensitive          | very sensitive          | less sensitive                 |
| Energy demand (electricity)     | high                    | medium                  | low                            |
| Maintenance                     | sophisticated           | medium                  | low                            |

Table 5. Characteristics of sludge dewatering equipment

(1) Polyelectrolyte (usually cationic): 2-4 g/kg of DS.

(2) Sludge conditioning with inorganic chemicals (iron salts and lime) is not strictly necessary, but recommendable for enhancing filtration rate and general performance.

(3) About 10 m<sup>3</sup>/h of clean water at 4 bars per meter of belt width are required for continuous belt washing.

(4) Periodical cleaning of filtering cloth is required (at least once per week).

| Treatment stage, equipment  | DS content % |
|---|--------------|
| Sludge after primary clarifier  | 3-5          |
| Thickened mixed primary and secondary sludge<br>(at a specific load of about 60 kg DS/m <sup>2</sup> )* | 6-8          |
| Chamber-filter press with chemical conditioning   | 35-45        |
| Belt-filter press with use of PE  | 20-25        |
| Centrifuge – decanter   | 20-30        |
| Sludge after stabilization with CaO<br>(mostly after belt-filter press or centrifuge)                   | 60-90        |

\* Average values for mixed (primary + secondary) tannery sludges

**Table 6. Dry matter content in sludge depending on process stage and/or type of dewatering equipment**

## 4.2 Utilization and disposal

In comparison with sanitary sludges, tannery sludge has greater inorganic matter content, greater heavy metal content, especially chromium and greater sulfur compound content. However, the main stumbling block is the chromium content, with legislation and practice varying a lot from country to country.

A number of solutions for utilization and/or safe disposal of tannery sludge have been proposed, practiced, tested, and applied at pilot and industrial scale: landfill, land application, composting, anaerobic digestion, thermal treatment, vitrification, pyrolysis, brick making, etc., none of them proving satisfactory enough. There is certainly no universal solution for sludge utilization/application. Each ETP produces sludge of specific characteristics and different regions and countries have quite different regulations regarding sludge utilization. Therefore, prior to any ETP construction, a detailed assessment of options should be prepared and the most suitable application proposed.

In any case, handling, storage and transport of sludge and solid wastes from PTPs and ETPs should also be safe and not contaminate the surroundings; thus, for example, the collection points should be protected against bad weather (rain, for example).



**Photo 13. Containers for solid waste**

## **5. The issue of bad odour**

Odours associated with wastewater are difficult to quantify because they are caused by a wide variety of compounds and they are a nuisance that is more qualitative than quantitative – sensitive persons easily detect very low concentrations of odoriferous substances in the air (sulphides/other sulphur compounds, ammonia, amines, etc.). Local geographic and climatic conditions such as wind direction, land shape, air humidity, ground and air temperature, etc. play an important role. Along the treatment line, the main sources of bad smell are:

- equalization and sulphide oxidation;
- sludge thickening;
- biological aeration;
- in-plant storage of dewatered sludge;
- (temporary) sludge disposal site.

Yet, the main source of bad smell remains the stripping of hydrogen sulphide; it is not the concentration of sulphide per se, but the lowering of pH: the not disassociated  $\text{H}_2\text{S}$  is present only at pH below 10. Thus, it is crucial to control pH and, if needed, alkalis like NaOH or lime are added to achieve pH > 9.5-10. More extensive, uninterrupted aeration may help, but sometimes rigorous (and expensive) methods such as adding hydrogen peroxide or pure oxygen are necessary. Nowadays, in some places, nearly the entire ETP is covered and the air is purified.



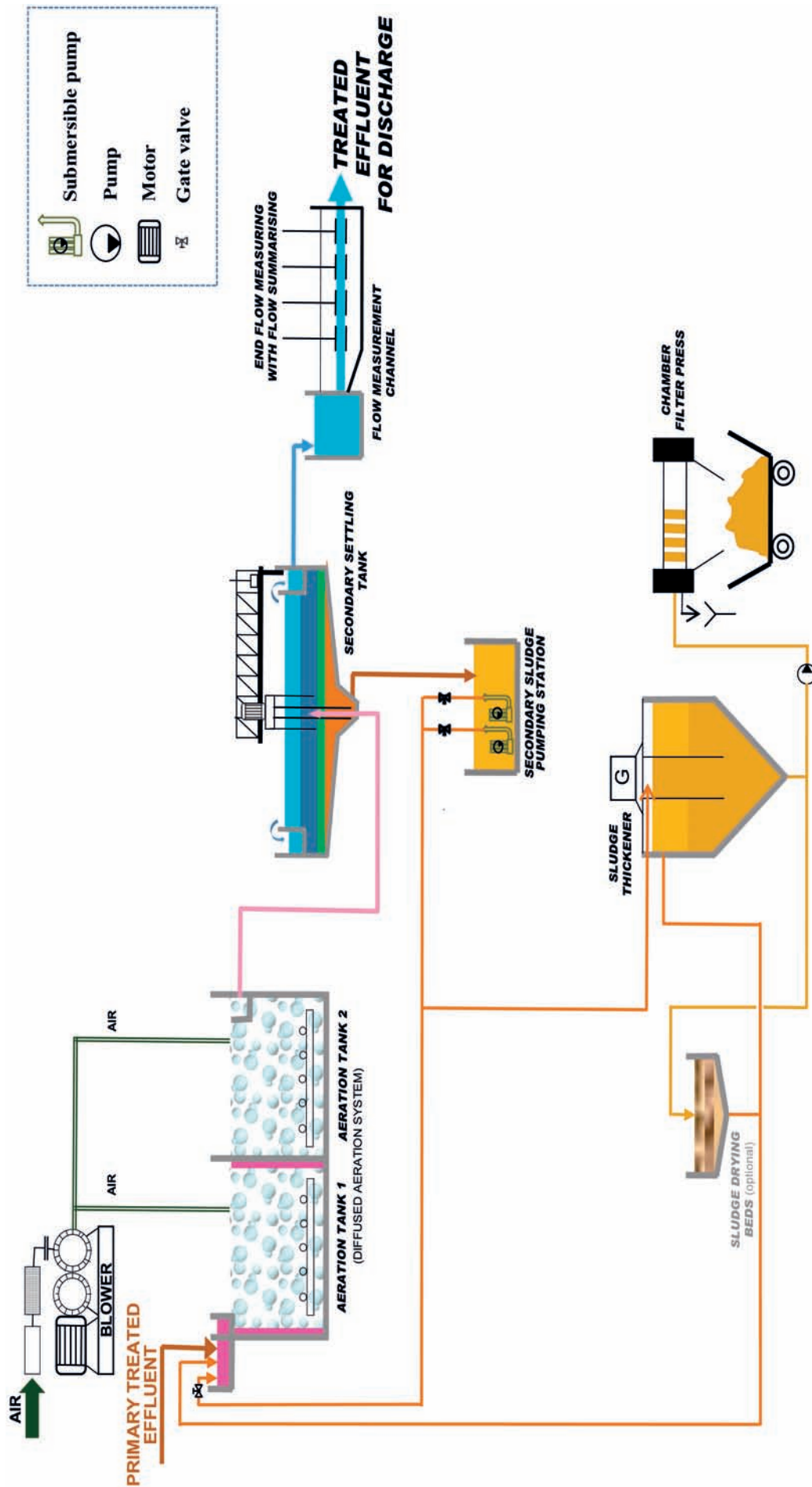

Figure 33. Simplified flowchart of the biological (secondary) tannery effluent treatment

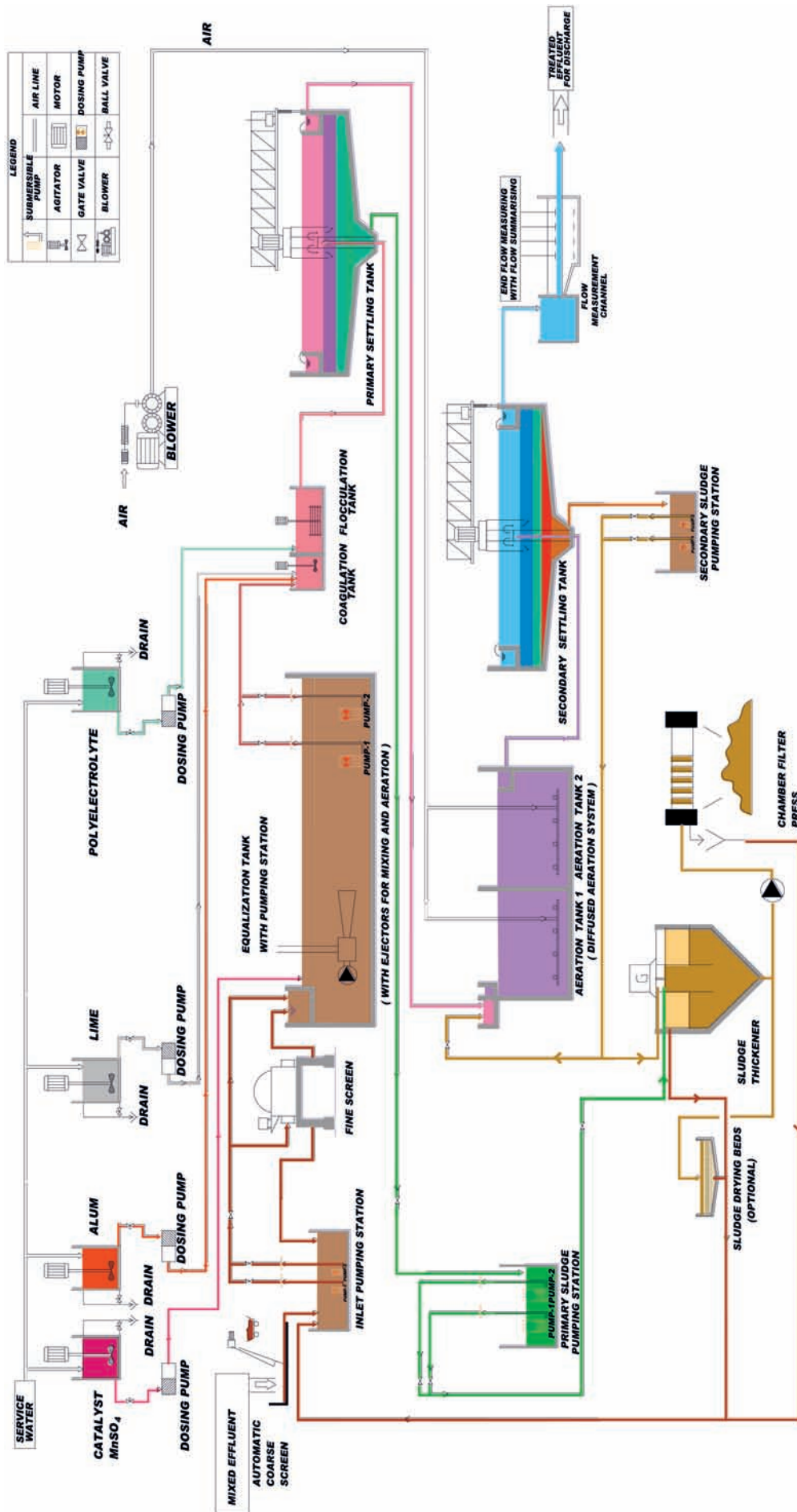

Figure 34. Simplified flowchart of a full-fledged tannery effluent treatment plant

## 6. Monitoring, costs, OSH, management

The extent of monitoring activities largely depends on local legal requirements and ETP size and it includes a wide range of parameters: effluent volume(s), peak loads, pollution loads, chemical dosing, dissolved oxygen (DO), sludge volume index (SVI), etc.

The costs of treatment vary a lot, depending on the local costs of:

- power;
- chemicals;
- financing;
- labour;
- sludge utilization and disposal options, etc.

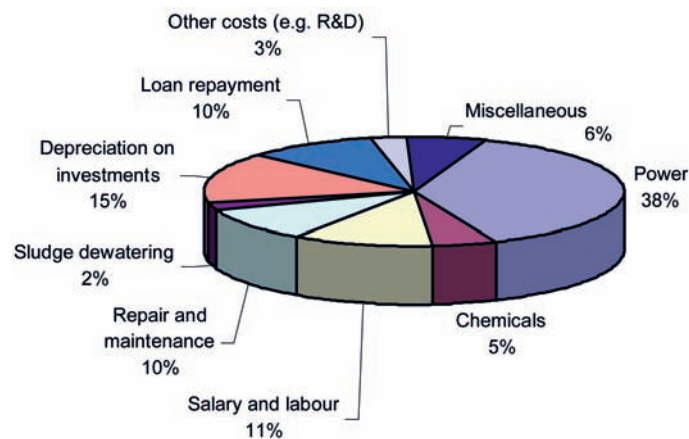

Figure 35. Structure of average treatment costs at selected CETPs in India in 2005

In developing countries, the largest component is power, while sludge handling and disposal costs are comparatively low. If the reverse osmosis (RO) stage for desalination is installed, the cost of energy escalates further. In industrialized countries, the largest cost component is dewatering and safe disposal of solids (sludge).

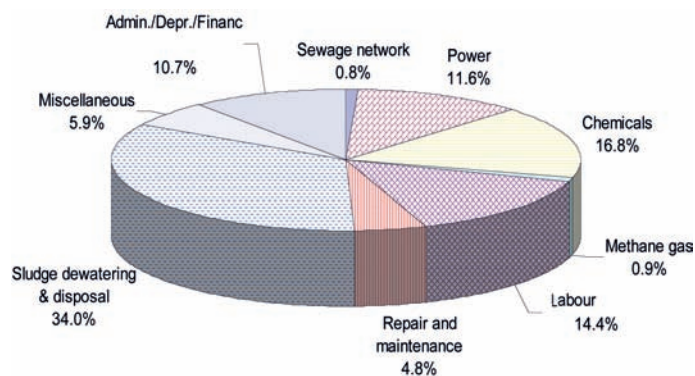

Figure 36. Distribution of average total costs at selected CETPs in Italy

While working out the costs of an ETP at an individual tannery is quite straightforward, different methods are applied to compute the distribution of CETP operation costs among individual tanneries. The key parameters used are typically the following:

- water consumption, m<sup>3</sup>/day;
- production capacity, tonnes of wet-salted hides/day;
- actual pollution load in terms of COD, suspended solids, sulphides and Cr;
- production output, m<sup>2</sup>/day of wet blue, crust or finished leather.

In developing countries, cost calculation methods for CETPs are usually very simple, being based solely on effluent volume and type of tanning, whereas in Italy, for example, these methods are very sophisticated and are based on many factors measured on-/off-line or estimated.

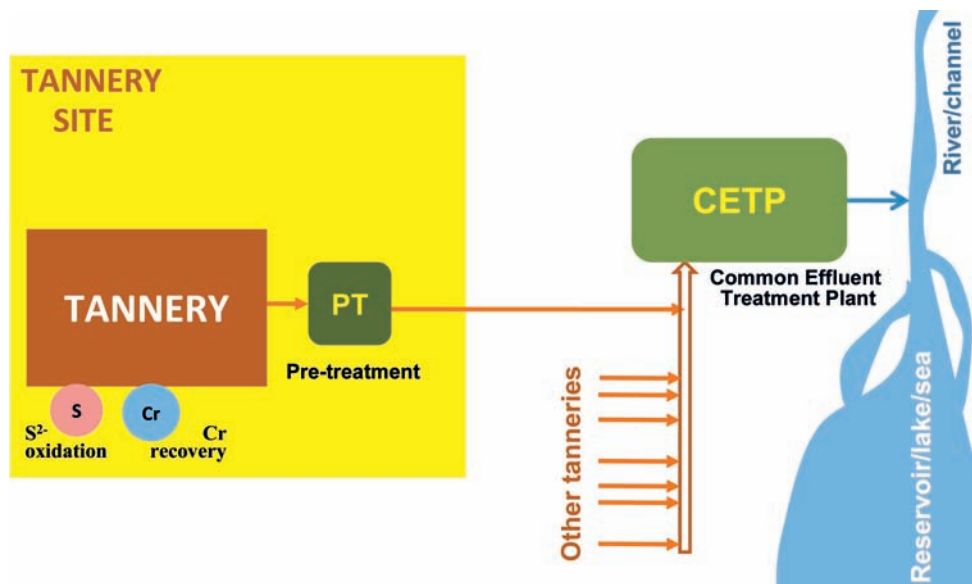

Figure 37. Schematic chart of typical effluent treatment setup for clusters in developing countries

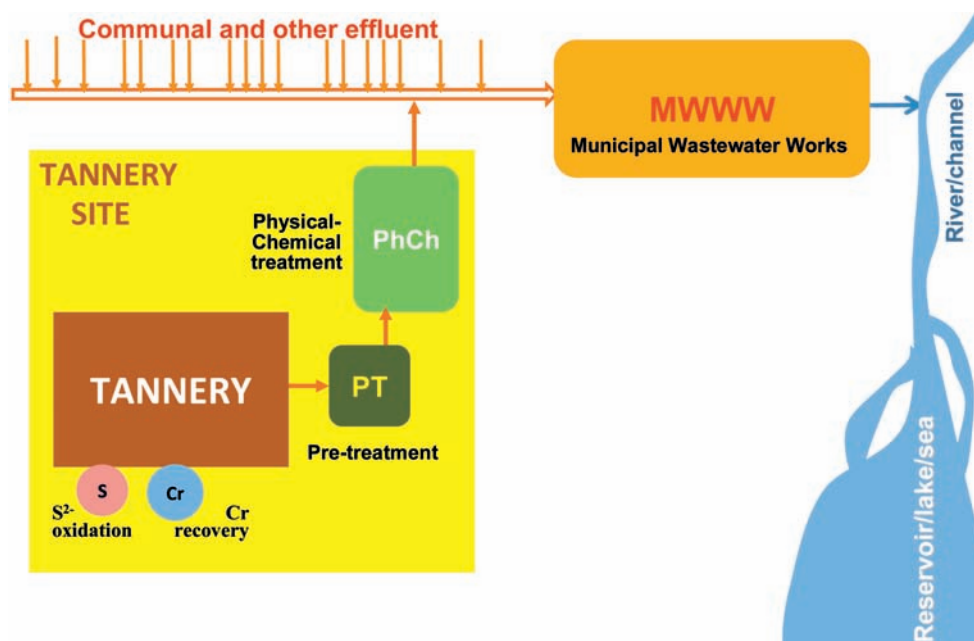

Figure 38. Schematic chart of typical effluent treatment setup in industrialized countries

When it comes to occupational safety and health at work (OSH) in (C)ETPs, the main focus is on hydrogen sulphide gas. As mentioned earlier, hydrogen sulphide is an extremely toxic and irritating gas. It has a strong odour of rotten eggs but, paradoxically, it is perceived only at lower concentrations. This explains the numerous accidents despite its known toxicity.

| Exposure ppm | Time             | Impact on unprotected person  |
|--------------|------------------|---|
| 0.03         | No time limit    | No effect   |
| 0.08-2.0     | No time limit    | (Ma)odour threshold   |
| 10           | Up to 8 hours    | No effect   |
| 15           | Up to 15 minutes | Threshold limit value   |
| 15-200       | Up to 15 minutes | Headache, nausea, general weakness, pain in legs  |
| 200-500      | One minute       | Irritation of nose and throat, vertigo, blurring of vision, loss of consciousness lasting a few minutes |
| 500-900      | One minute       | Profound coma, convulsions, disorientation after recovery   |
| > 900        | One minute       | Instant coma and death  |

ppm = parts per million

**Table 7. Poisoning effects of hydrogen sulphide gas (H<sub>2</sub>S)**

New toxicological data have led authorities in some countries to start reducing the recommended chronic-exposure limits to hydrogen sulphide – the 8-hour time-weighted average of the threshold limit value (TLV-TWA8) for H<sub>2</sub>S came down from 10 ppm to 1 ppm, and the short-term exposure limit (TLV-STEL) from 15 ppm to 5 ppm; as a result, even confirming compliance with the new standards will be a challenge.

Instruments used to detect and monitor H<sub>2</sub>S exposure can be either fixed or portable, whereas personal detectors are worn by employees and typically sound an alarm at levels between 10 ppm and 15 ppm. Due to this nearly permanent life threatening hazard, H<sub>2</sub>S meters are always positioned at critical points and/or carried by staff. Also, certain activities such as entering pits can be carried out only in the presence of skilled supervisors (the worker performing such an operation must also wear a safety harness).

Otherwise, general and specific measures concerning equipment and chemicals also apply to ETPs.

Nowadays it is taken for granted that in a well managed tannery there is a person of appropriate competence and at an appropriate level of seniority who deals exclusively with increasingly complex environmental issues, especially those related to effluent treatment; in some countries, this is a legal requirement.

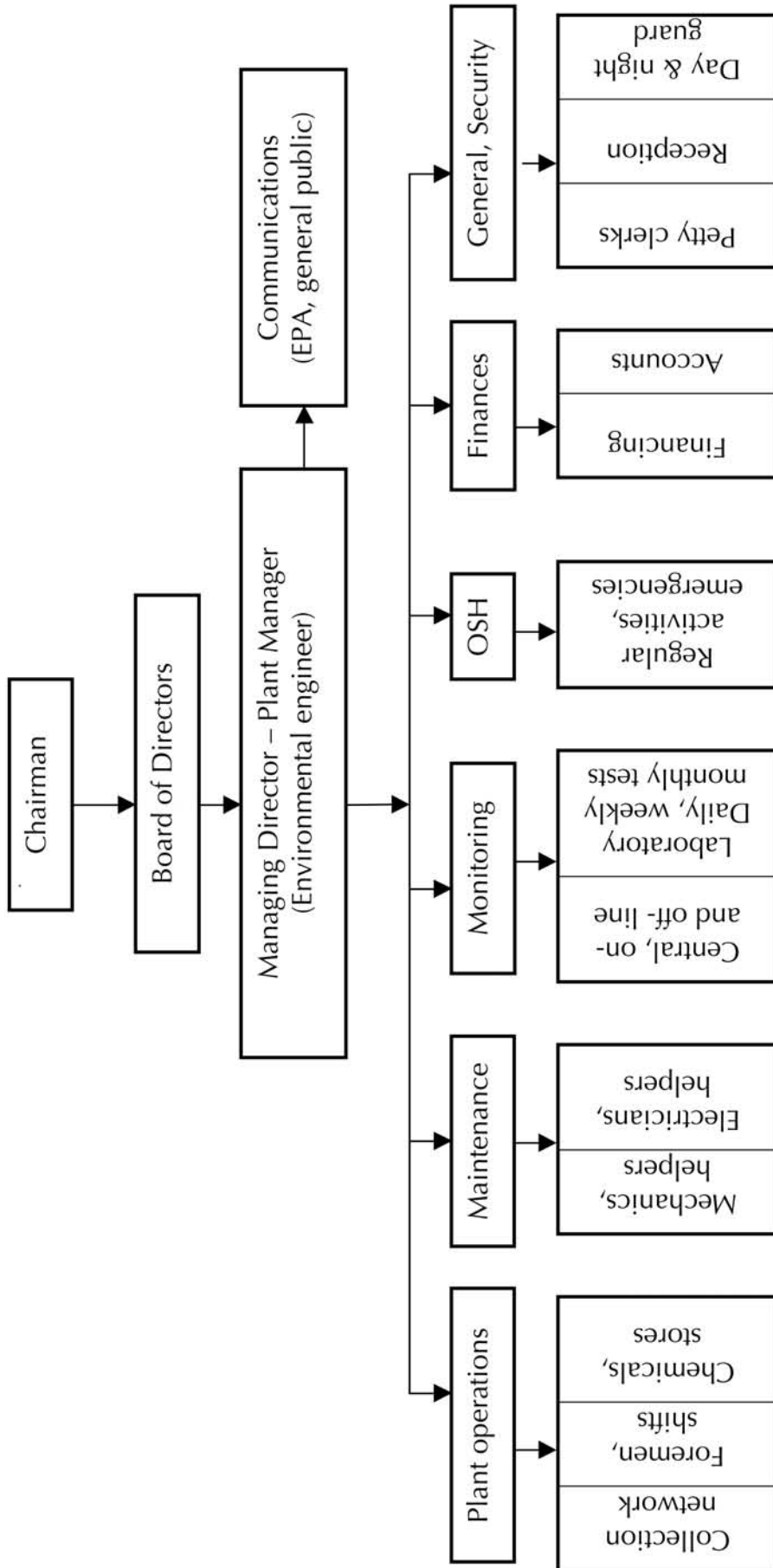

Figure 39. An example of CETP management setup

## 7. Conclusions

The treatment of tannery effluents is by now a well established technology, and modular common effluent treatment plants servicing traditional tannery clusters or newly created leather industry zones is a widely accepted approach. However, two issues still pose serious challenges:

- High TDS (salinity) content, unaffected by treatment. This problem is especially pronounced in developing countries where mixing tannery effluent with domestic sewage or its discharge into the sea is not feasible, and the raw hides and skins are still preserved by salting. Relocation of tanneries to the seaside is often not feasible, and desalination of treated effluent by reverse osmosis is very expensive.
- Utilization or safe disposal of sludge.

Cost-effective solutions to both of these problems are still eagerly awaited.

# **Annexes**



Annex 1. General view of inputs and outputs in the leather sector

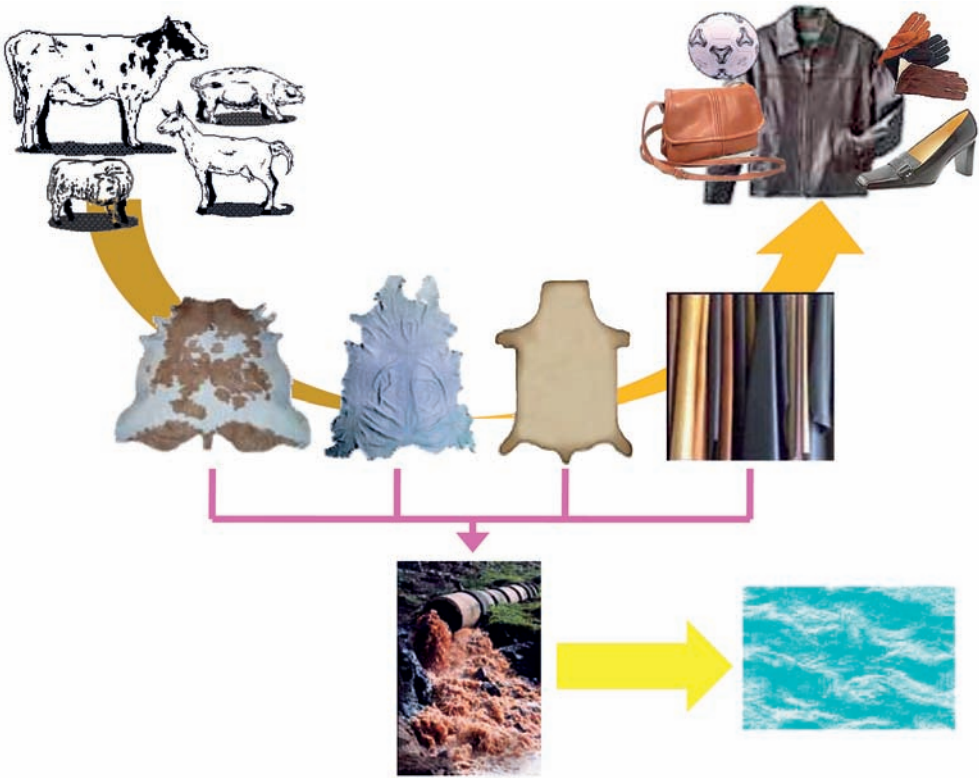

Annex 2. Chrome-recovery unit using NaOH



### Annex 3. Classification of pumps

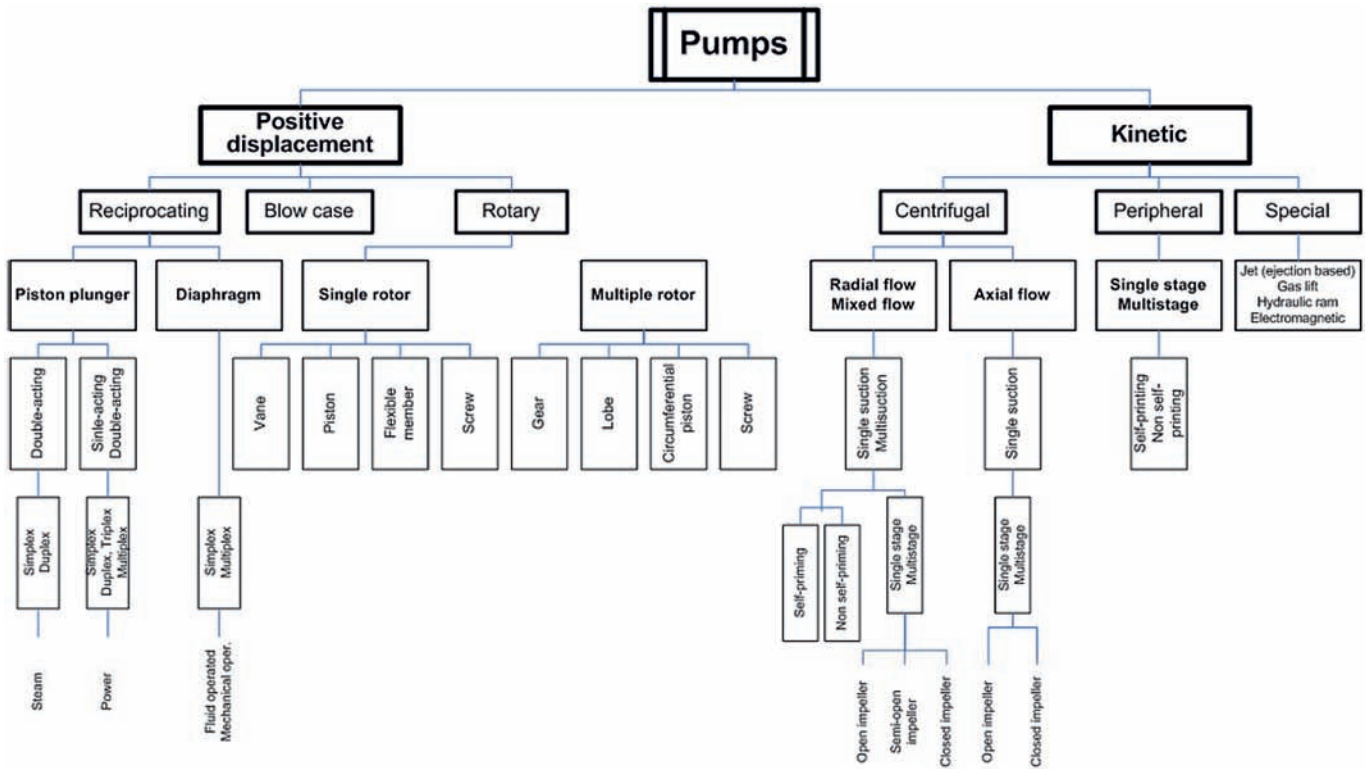

### Annex 4. A model of rotary screening drum

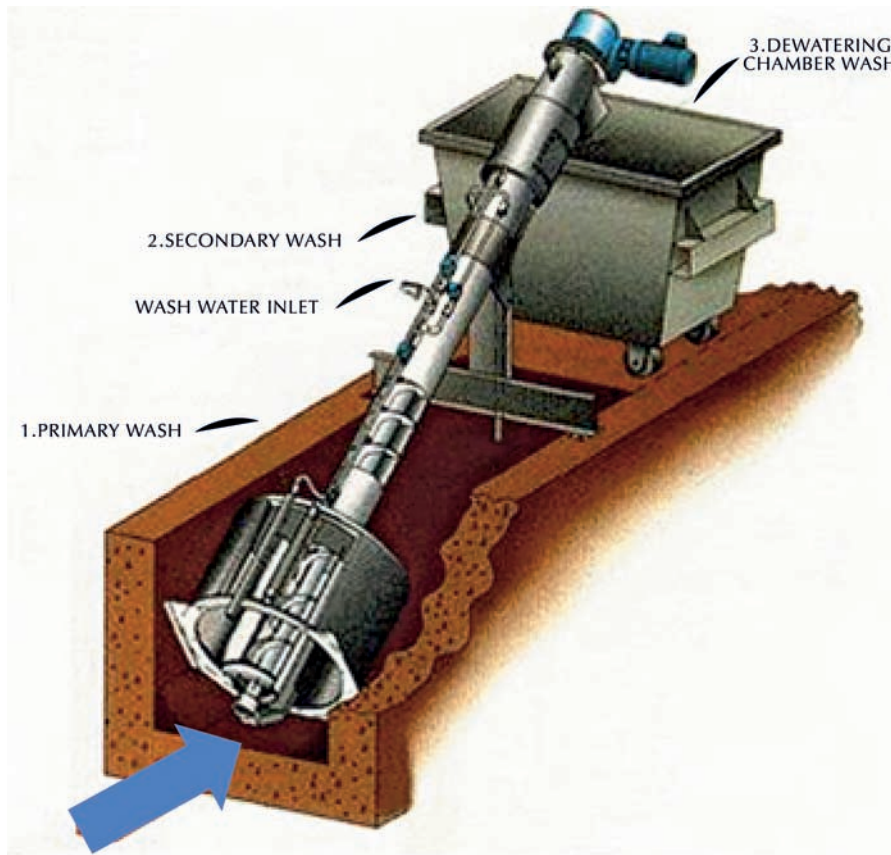

### Annex 5. Types of sedimentation tanks

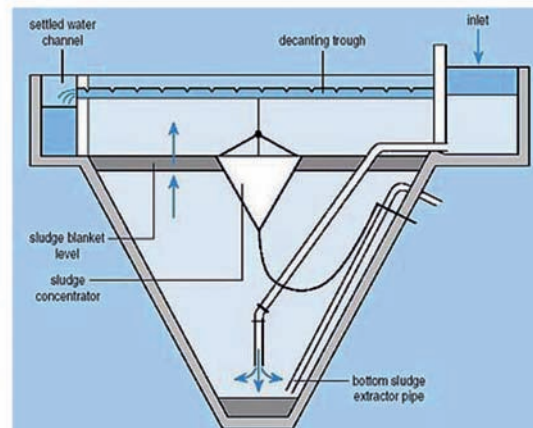
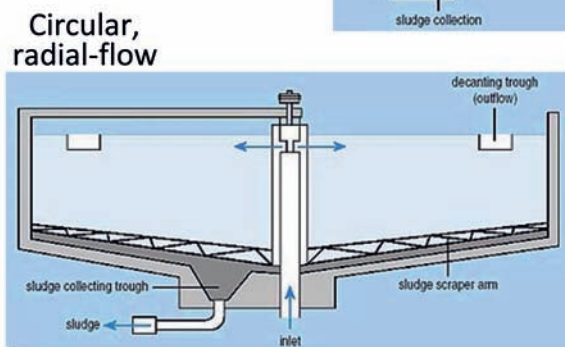
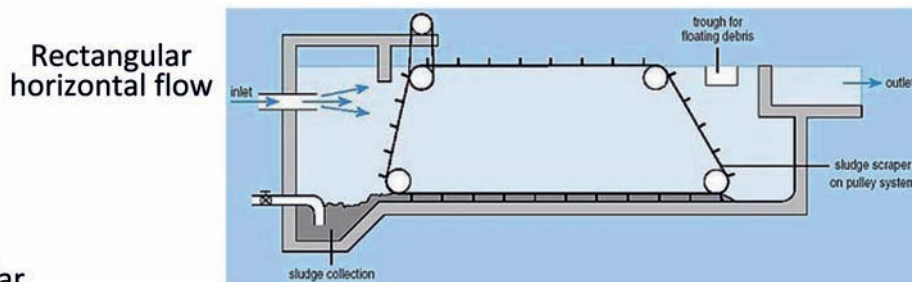

## Annex 6. Photos and cross section of a circular sedimentation tank

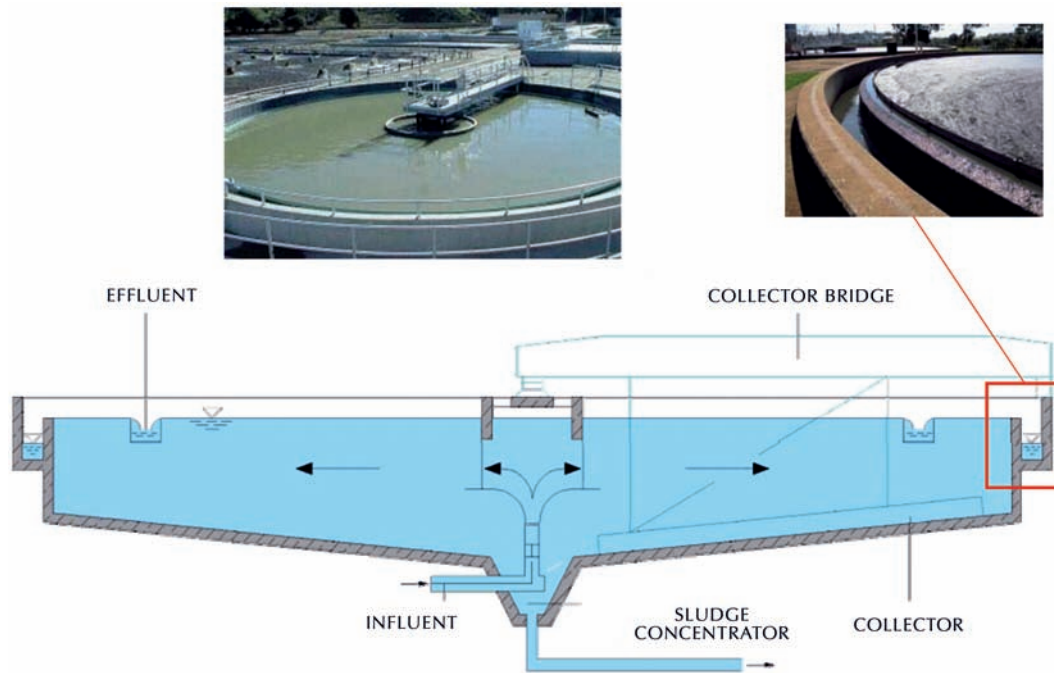

## Annex 7. Sludge production in leather processing

| Process                            | Primary sludge production                                |   | Total sludge production   |   |
|------------------------------------|--|---|---|---|
|                                    | Dry matter per tonne of wet-salted hides/skins processed | Liquid sludge (4% solids) per tonne of hides/skins (litres) | Dry matter per tonne of wet-salted hides/skins processed (litres) | Liquid sludge (4% solids) per tonne of hides/skins (litres) |
| Pulp hair and chrome tanning       | 80-120 kg  | 2,000-3,000   | 100-150   | 2,500-3,800   |
| Pulp hair vegetable tanning        | 80-150 kg  | 2,000-4,000   | 120-150   | 3,000-4,500   |
| Wet-blue or semi-processed leather | 30-40 kg   | 800-1,000   | 40-50   | 1,000-1,300   |

Annex 8. Classification of mechanical aerators

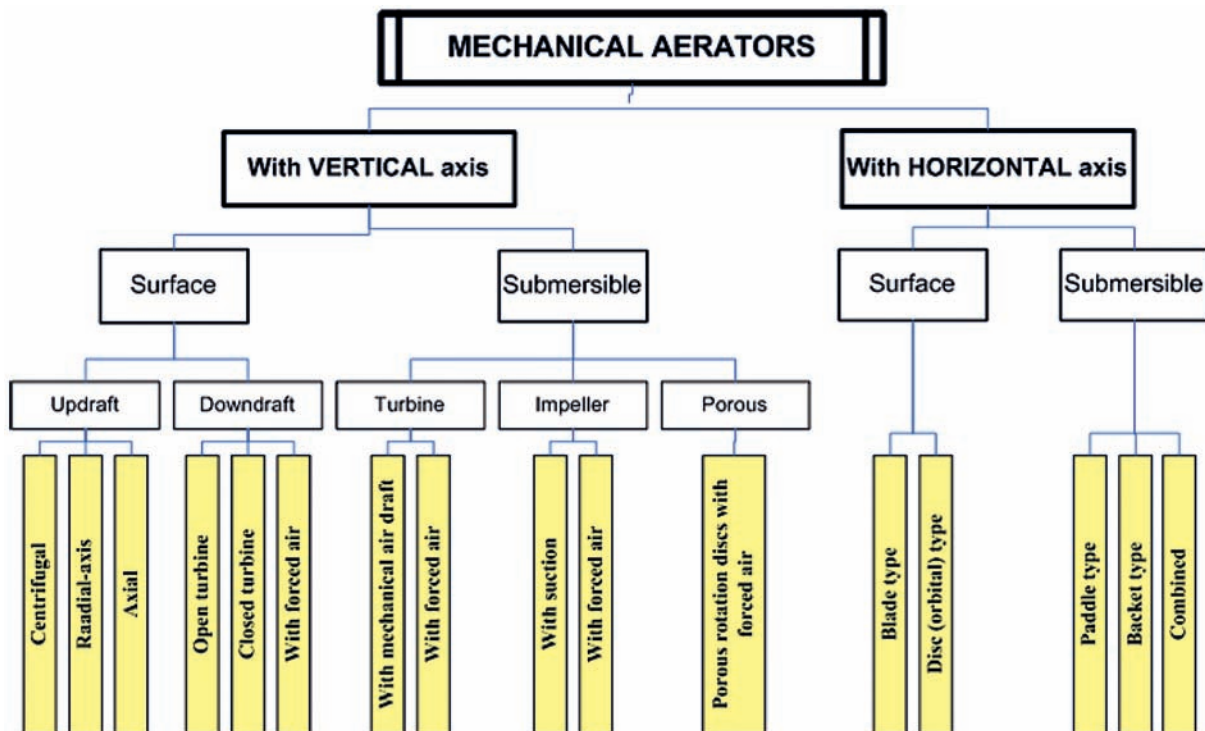

## Annex 9. Scheme of the membrane bioreactor (MBR)

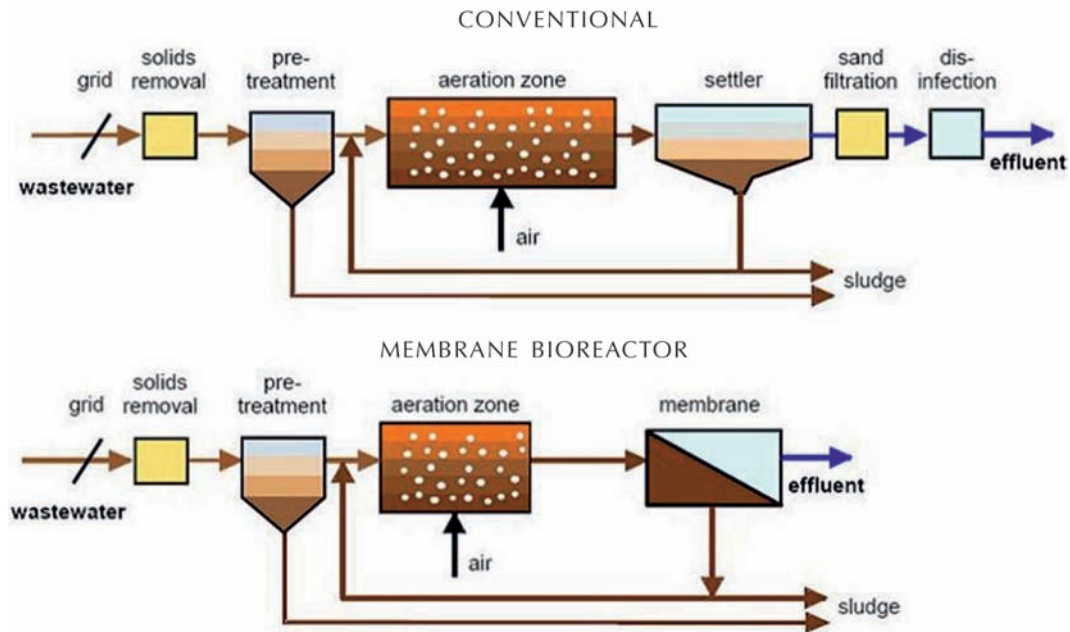

## Annex 10. Personal hydrogen-gas monitor

**Key features**

- Large, easy-to-read continuous display of gas concentration in ppm
- Displays STEL, TWA, peak values, and alarm minutes used
- User-adjustable High, Low, STEL and TWA alarms
- Varying audio alarm signals for different alarm conditions
- Bright red flashing alarm
- Loud, 90 dB buzzer
- Built-in vibration alarm
- Holds peak values
- Simple calibration
- Durable, highly impact-resistant, carbon-loaded ABS housing
- Highly resistant to RF interference
- Hands-free use: clips onto a hardhat, shirt pocket, shoulder strap or belt



Note: This is one of many brands in the market.

Annex 11. Reverse osmosis (RO): principle, diagram, photo of a small RO unit

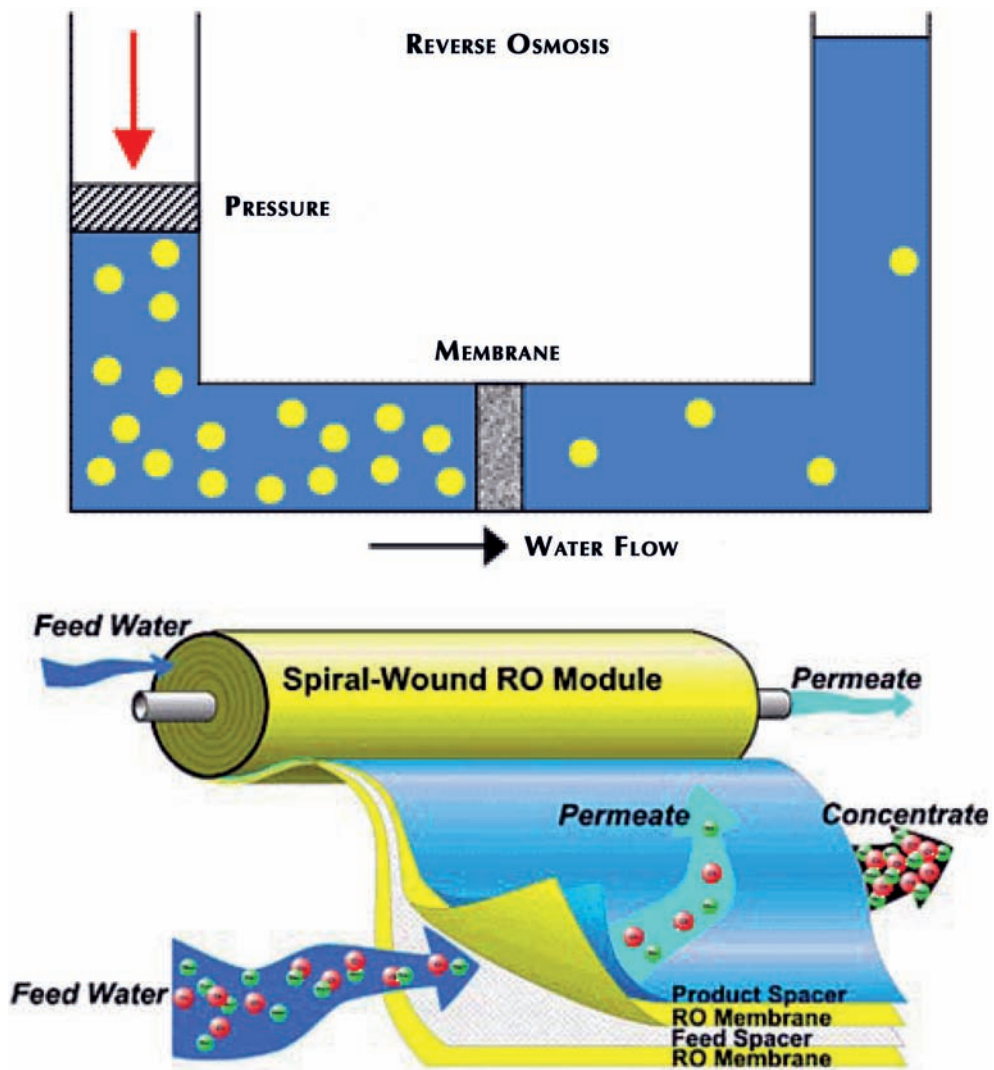

Annex 12. Schematic view of constructed wetland – reed beds

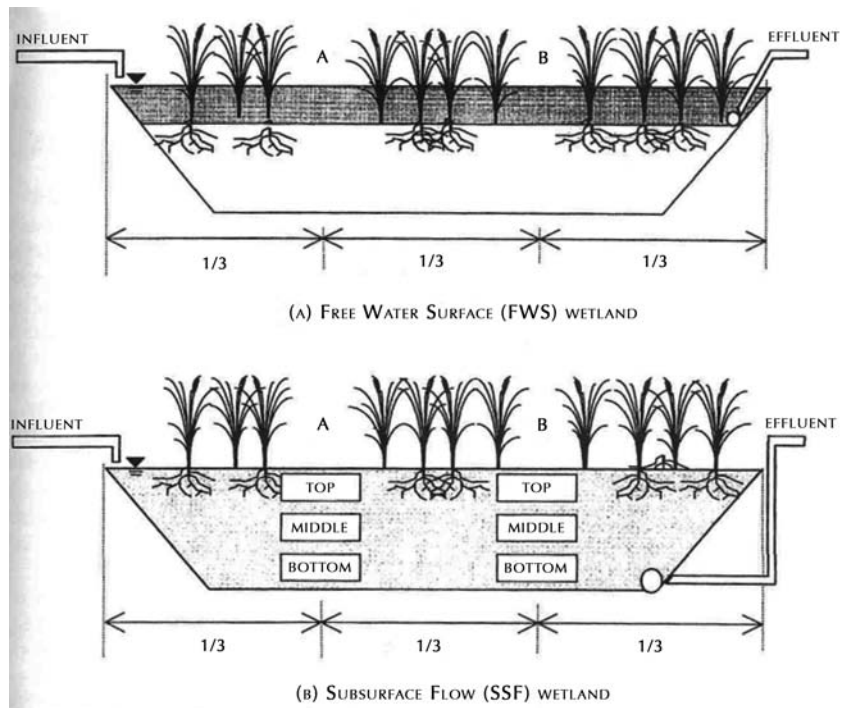



### Annex 13. Aerated static composting pile

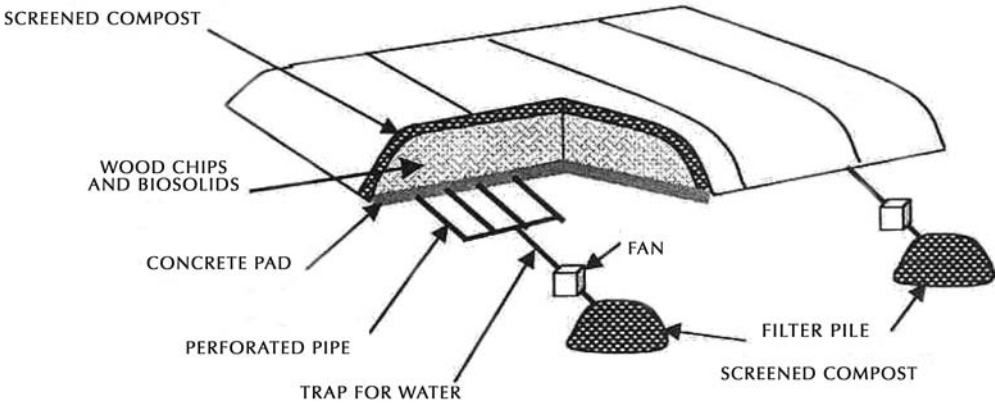

## Annex 14. Typical fluxogram of an ETP

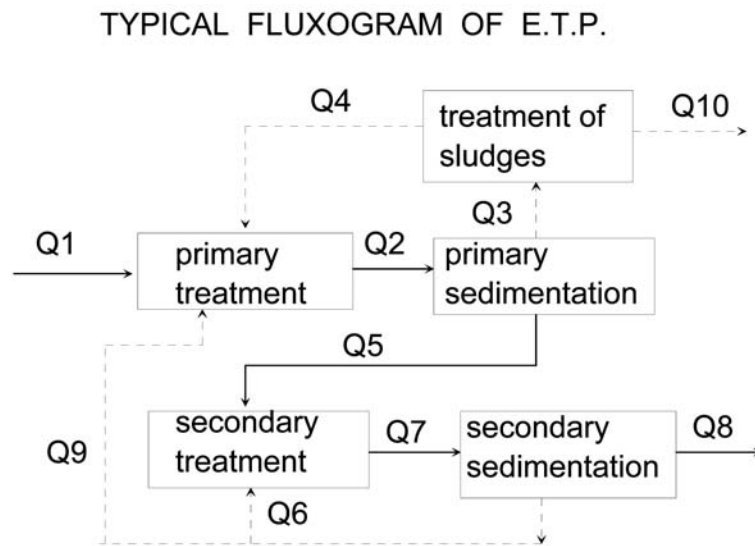

Q1 = volume discharged by the tannery

Q2 =  $Q1 + Q4 + Q9$

Q3 = volume of the liquid sludge

Q4 =  $Q3 - Q10$  (water from sludge treatment )

Q5 =  $Q2 - Q3$  (influent to biological treatment)

Q6 = biological sludge recycle

Q7 =  $Q5 + Q6$

Q8 =  $Q1 - Q10$  (volume of the treated effluent)

Q9 = excess of biological sludge

Q10 =  $Q3 - Q4$  (volume of dewatered sludge)

It can be approximated that:

The volume of raw effluent = influent to biological treatment = volume of treated effluent.

## Annex 15. A dialogue between a tanner and an environmental engineer

### Information to be provided by the tanner:

- Production: daily input and types of raw material (hides, skins; fresh/wet-salted), processing stage (wet blue, crust, finished), working days (per week/year, any closure periods), number of employees.
- Process – present, plans for the future: biocides used, hair-save unhairing, deliming on low dose of ammonium salts, any degreasing, chrome management (direct recycling, high exhaustion, recovery).
- Effluent emissions:
  - industrial (beamhouse, tanyard, general), segregation, total/peak/average flow, discharge distribution over the day;
  - rainwater – separate drainage, not mixed with industrial effluent;
  - sanitary effluents – separate drainage, not mixed with industrial effluent.
- Raw effluent quality – detailed laboratory analysis of each of the three industrial streams and/or combined effluent: BOD<sub>5</sub>, COD, SS, Cr, TKN, NH<sub>3</sub>-N, chlorides, sulphates (TDS).
- Nature of the recipient of treated effluent: sewage, open water body (river, lake).
- Officially (locally) prescribed quality of treated effluent – discharge limits.
- Area available for the ETP.
- Distance to residential areas.
- Any local solution for utilization and/or disposal of (chrome-containing) sludge.

Information about the local climate (temperatures, precipitations, wind directions), unit cost of electricity and chemicals, primarily polyelectrolytes, as well as labour costs should also be required if necessary.

### Questions a tanner should ask:

In addition to obvious questions concerning investment and operation costs, the tanner should specifically focus the discussion on:

- A detailed explanation regarding the logic of the overall technical concept.
- A comparative evaluation of technical alternatives, e.g., bottom diffusers vs. Venturi ejectors for aeration, conventional tank vs. oxidation ditch for biology, frame-filter press vs. decanter centrifuge, etc.
- The rate of purification for each treatment stage.
- Emergency procedures – back-up arrangements in case of the failure of parts or larger components of the treatment system (e.g., collapse of the biological treatment).
- Occupational safety and health measures, including personal protection equipment (PPE).
- A concise overview of on- and off-line monitoring and control parameters, including the expected value ranges at critical points (presence of H<sub>2</sub>S, COD, DO, settleability, DS content, etc.).
- Performance guarantee – warranty concerning the quality of the treated effluent in conformity with local legislation (discharge limits).
- “If scenarios” – provisions/buffers/safety margins/retrofitting/upgrades in case of failure to meet (additional) norms.

## Annex 16. Basic plant monitoring and control

Local legal requirements are crucial in determining the extent and frequency of tests conducted to monitor and control ETP performance to satisfy discharge limits. Obviously, for that purpose, full laboratory tests in accordance with (international) standardized procedures are required. However, regular monitoring of key parameters is also important for optimizing the treatment process and reducing operation costs.

It is also assumed that recording of some parameters like effluent volumes is automated and that H<sub>2</sub>S meters are always positioned at critical points and/or carried by staff in accordance with Occupational Safety and Health (OSH) norms and procedures.

| Item   | Daily           | Weekly |
|--|-----------------|--------|
| 1. Primary treatment   |                 |        |
| 1.1 Equalization tank  |                 |        |
| Suspended solids, SS (mg/l)  |                 | X      |
| Settleable solids in Imhoff cone (ml/l)  | X               |        |
| Sulphides, qualitative (with lead acetate paper)                               | X               |        |
| Sulphides, quantitative (mg/l)   |                 | X      |
| pH   | X               |        |
| Chrome <sup>3+</sup> (mg/l)  |                 | X      |
| COD of mixed and settled (supernatant) sample (mg/l)                           |                 | X      |
| 1.2 Flocculation   |                 |        |
| Visual appreciation of the process   | X               |        |
| Dosage of chemicals  | X               |        |
| pH   |                 |        |
| 1.3 Outlet of the primary settling tank  |                 |        |
| Suspended solids, SS (mg/l)  |                 | X      |
| Settleable solids in Imhoff cone (ml/l)  | X               |        |
| Sulphides, qualitative (with lead acetate paper)                               | X               |        |
| Sulphides, quantitative (mg/l)   |                 | X      |
| pH   | X               |        |
| Chrome <sup>3+</sup> (mg/l)  |                 | X      |
| COD of mixed and settled (supernatant) sample (mg/l)                           |                 | X      |
| BOD <sub>5</sub> (mg/l)  |                 | X      |
| 2. Biological treatment  |                 |        |
| 2.1 Aeration tank  |                 |        |
| MLSS and MLVSS   |                 | X      |
| Sulphides, qualitative (with lead acetate paper)                               | X               |        |
| SVI  | X               |        |
| DO   | X               |        |
| pH   | X               |        |
| 2.2 Outlet of the secondary settling tank                                      |                 |        |
| BOD <sub>5</sub> , (mg/l)  |                 | X      |
| COD of mixed and settled (supernatant) sample (mg/l)                           |                 | X      |
| Suspended solids, SS (mg/l)  |                 | X      |
| Settleable solids in Imhoff cone (ml/l)  | X               |        |
| 2.3 Secondary sludge recirculation   |                 |        |
| DS content of the surplus sludge (mg/l or %)                                   |                 | X      |
| 3. Sludge treatment  |                 |        |
| Quantity of the primary sludge (m <sup>3</sup> /day)                           | X               |        |
| DS content of the sludge (% of volume)   | X               | X      |
| Quantity of secondary sludge – if not mixed with primary (m <sup>3</sup> /day) | When discharged |        |

## Annex 17. Discharge limits for treated tannery effluents in France, Italy and India

| Parameter                                     | Unit | France   |         | Italy   |         | India          |                |
|---|------|----------|---------|---------|---------|----------------|----------------|
|   |      | Surface  | Sewer   | Surface | Sewer   | Surface        | Sewer          |
| pH  | –    | 6.5-8.5  | 6.5-8.5 | 5.5-9.5 | 5.5-9.5 | 5.5-9.0        | 5.5-9.0        |
| COD   | mg/l | 125      | 2000    | 160     | 500     | 250            | –              |
| BOD <sub>5</sub>                              | mg/l | 30       | 800     | 40      | 250     | 30             | 350            |
| Suspended solids                              | mg/l | 35       | 600     | 40-80   | 200     | 100            | 100            |
| Ammonia nitrogen<br>(as NH <sub>4</sub> )     | mg/l | –        |         | 15      | 30      | 50             | 50             |
| TKN   | mg/l |          |         |         |         | 100            |                |
| Nitrate nitrogen (as N)                       | mg/l | –        |         | 20      |         | –              |                |
| Total nitrogen<br>in sensitive areas          | mg/l | 30<br>15 | 150     |         |         | –              |                |
| Sulphide (S <sup>2-</sup> )                   | mg/l |          |         | 1       | 2       | 2              | –              |
| Hexavalent chromium,<br>Cr <sup>6+</sup>      | mg/l | 0.1      | 0.1     | 0.2     | 0.2     | 0.10           | 2.0            |
| Trivalent chromium, Cr <sup>3+</sup>          | mg/l | 1.5      | 1.5     | -       | 4.0     | –              | –              |
| Total chrome<br>(as Cr)                       | mg/l | –        |         | 2.0     | 4.0     | 2              | 2              |
| Iron + aluminium                              | mg/l | 5        | 5       |         |         | –              |                |
| Phenol index                                  | mg/l | 0.3      |         |         |         | 1 <sup>1</sup> | 5 <sup>1</sup> |
| AOX   | mg/l | 1.0      | 1.0     |         |         | –              |                |
| Chlorides (as Cl <sup>-</sup> )               | mg/l | ***      |         | 1200*   | 1200    | **             | **             |
| Sulphates (as SO <sub>4</sub> <sup>2-</sup> ) | mg/l | ***      |         | 1000*   | 1000    | 1000           | 1000           |
| Aluminium (as Al)                             | mg/l | –        | –       | 1.0     | 2.0     | –              | –              |
| Iron (as Fe)                                  | mg/l | –        | –       | 2.0     | 4.0     | –              | –              |

<sup>1</sup>As phenolic compounds (as C<sub>6</sub>H<sub>5</sub>OH).

\* Special limits permitted by the regional authorities to certain CETPs located close to the sea or if the effluent is mixed with sanitary wastewater:

- at Santa Croce, CuoioDepur and Fuccechino – chlorides: 5,000 mg/l; sulphates: 1,800 mg/l;
- at Arzignano – chlorides: 900 mg/l; sulphates: 1,800 mg/l;
- at Solofra – chlorides: 3,500 mg/l; sulphates: 1,500 mg/l.

\*\* In Tamil Nadu, India – TDS limit: 2,100 mg/l; chlorides: 1,000 mg/l; sulphates: 1,000 mg/l, for discharge in surface water and sewer. Previously, up to 7,500 mg/l TDS were tolerated by the authorities.

\*\*\* In France, no discharge limits pertaining to chlorides, sulphates and TDS have been prescribed except in special cases. (The authorities do not insist on norms relating to COD and nitrogen, if the effluent is treated alongside with domestic sewage in a combined treatment plant. This relates exclusively to effluent discharged in a sewer).

Note: The data in the table above refer to the year 2002.

## Annex 18. Typical tannery ETP auxiliary chemicals and their dosing\*

| Process stage/purpose   | Chemical                              | Normally supplied as  | Usual dosage, industrial purity, in g/m <sup>3</sup> or g/kg of DS in sludge               | Usual concentration of solution g/l       |
|---|---------------------------------------|---|--|---|
| Catalytic oxidation of sulphides in mixed effluent                    | Manganese sulphate                    | Salt, MnSO <sub>4</sub> ·4H <sub>2</sub> O  | 30   | 100                                       |
| Inorganic coagulant   | Aluminium sulphate (alum)             | Usually as salt, Al <sub>2</sub> (SO <sub>4</sub> ) <sub>3</sub> ·18H <sub>2</sub> O, | 300  | 100                                       |
| pH correction /adjustment   | Hydrated lime, Ca(OH) <sub>2</sub>    | Powder, Ca(OH) <sub>2</sub> , large ETPs also buy CaO                                 | 300  | 100                                       |
| Flocculation  | Anionic polyelectrolyte               | –   | 1  | Mother solution 5 g/l, diluted to 0.5 g/l |
| Nutrient for optimum biological treatment (BPK : N : P = 100 : 5 : 1) | N present, only P salts may be needed | Salt or acid, Na <sub>3</sub> PO <sub>4</sub> or H <sub>3</sub> PO <sub>4</sub>       | Theoretically about 30, in practice adjusted to the actual ratio – proportions in effluent | 100                                       |
| Sludge conditioning, mainly for recessed-frame presses                | Ferric salts                          | Salt, FeCl <sub>3</sub> or in solution  | 85   | 100                                       |
| Sludge conditioning, mainly for recessed-frame presses, pH adjustment | Hydrated lime                         | Powder, Ca(OH) <sub>2</sub> , large ETPs also buy CaO                                 | 130  | 100                                       |
| Sludge conditioning, mainly for belt-filter presses                   | Cationic polyelectrolyte              | –   | 5  | 5   |
| Stabilization of dewatered sludge                                     | Lime                                  | Powder, CaO   | 50   | Direct mixing                             |

\* Always in solution.

## **Annex 19. Environmental effects of the main constituents of tannery effluents**

### **Solids**

#### **1. Suspended solids**

Suspended solids present in effluents are defined as the quantity of insoluble matter contained in the wastewater. These insoluble materials cause a variety of problems when discharged; essentially, there are two types of solids distinguished by significantly different characteristics.

##### **a. Solids with a rapid settling rate (settleable solids)**

If wastewaters are to be treated in sewage works or to undergo traditional effluent treatment, the main problems that arise are due to the large volume of sludge that forms as the solids settle. Sludge often contains up to 97% water, giving rise to huge quantities of “light” sludge. Even viscous sludge has a water content of about 93% and can easily block sumps, sludge pumps and pipes. All this sludge has to be removed, transported, dewatered, dried and deposited, thus placing an inordinate strain on plant, equipment and resources.

Even a thin layer of settled sludge can become a blanket that deprives sections of the river or lake bed of oxygen. As a result, aquatic life dies and decomposition sets in.

##### **b. Semi-colloidal solids**

Semi-colloidal solids are very fine solids that, for all practical purposes, will not settle out even if the effluent is left to stand for a considerable period of time. Semi-colloidal solids will not directly cause a sludge problem. They can be broken down over an extended period by bacterial digestion and produce solids, which will eventually settle.

#### **2. Gross solids**

Gross solids are larger than those a sampling machine can handle; hence they are not measured. Their presence, however, is clear to see and the dangers they pose are fully recognized. The waste components that give rise to this problem are often large pieces of leather cuttings, trimmings and gross shavings, fleshing residues, solid hair debris and remnants of paper bags. They can be easily removed by means of coarse bar screens set in the wastewater flow. However, if they emerge from the factory, they settle out very rapidly.

Major problems can develop if these materials settle in the pipes since they lead to blockages. The problems can be very serious when blockages occur in inaccessible piping. The cost of replacing burned-out motors or broken rotors is high. If discharged into gullies, ditches or water courses, the debris rapidly accumulates causing blockages and leading to stagnation.

### **Oxygen demand**

Many effluent components are broken down by bacterial action into simpler components. Oxygen is required for both the survival of these (aerobic) bacteria and the breakdown of the components. Depending on effluent composition, this breakdown can be quite rapid or may take a very long time. If effluent with a high oxygen demand is discharged directly into surface water, the sensitive balance

maintained in the water becomes overloaded. Oxygen is stripped from the water causing oxygen-dependent plants, bacteria, fish – as well as the river or stream itself – to die.

The outcome is an environment populated by anaerobic bacteria (which are not oxygen-dependent) leading to toxic water conditions. A healthy river can tolerate substances with low levels of oxygen demand. The load created by tanneries, however, is often excessive, and the effluent requires treatment prior to discharge. In order to assess the impact of effluent discharge on surface waters or determine the cost of treatment, oxygen demand needs to be determined. This can be done in two different ways:

### **1. Biochemical oxygen demand (BOD<sub>5</sub>)**

The BOD<sub>5</sub> analysis, generally called BOD, is widely used to assess the environmental demands of wastewater. It should also be noted that, while BOD is a measure of the oxygen requirements of bacteria under controlled conditions, many effluent components take longer than the period of analysis to break down. Some chemicals will only be partially broken down, while others may not be significantly affected. Typically, vegetable tanning wastes have a long breakdown period, often quoted as being up to 20 days. These longer digestion periods can apply to a variety of chemicals used in manufacturing leather, including certain re-tanning agents, some synthetic fat liquors, dyes, and residual proteins from hair solubilization.

This longer breakdown period means that the environmental impact is spread over a larger area as wastewater components are carried over greater distances before breaking down.

### **2. Chemical oxygen demand (COD)**

This method measures the oxygen required to oxidize the effluent sample entirely. It sets a value for the materials that would normally be digested in the BOD<sub>5</sub> analysis, the longer-term biodegradable products, as well as the chemicals that remain unaffected by bacterial activity.

The semi-colloidal material in suspended solids is also included in the BOD and COD determinations. Normally 1 mg/l of suspended solids will generate a COD increase of approximately 1.5 mg/l.

### **Nitrogen**

Nitrogen is contained in several tannery effluent components. Sometimes, these sources have to be differentiated.

#### **Total Kjeldahl nitrogen (TKN)**

Several tannery effluent components contain nitrogen as part of their chemical structure. The most common chemicals are ammonia (from delimiting materials) and the nitrogen contained in proteinaceous materials (from liming/unhairing operations).

These sources of nitrogen pose two direct problems:

a. Plants require nitrogen in order to grow, but the high levels released by substances containing nitrogen over-stimulate growth. Water-based plants and algae grow too rapidly, whereupon waterways become clogged and their flow is impaired. As the plants die, a disproportionately high amount of organic matter has to be broken down. If the load outstrips the natural supply of oxygen from the river, plants, fish and aerobic bacteria die and ultimately anaerobic conditions develop.



b. The nitrogen released through protein breakdown and the deliming process is in the form of ammonia. Bacteria can convert the latter over several stages into water and nitrogen gas, which is ultimately released into the atmosphere. Both of these breakdown products are non-toxic, yet large amounts of oxygen are needed in the process. If oxygen demand is greater than the level supplied naturally by the body of water, toxic anaerobic conditions can rapidly develop.

Combining intensive aerobic and anoxic biological treatment can break down the nitrogenous compounds. The oxygen demand is very high, thus leading to correspondingly high operational and energy costs. Calculations show that, with typical tannery effluent, some 40% of oxygen requirements are spent on removing the nitrogen component.

### **Sulphides (S<sup>2-</sup>)**

The sulphide content in tannery effluent results from the use of sodium sulphide and sodium hydrosulphide and the breakdown of hair in the unhairing process. Sulphides pose many problems. Under alkaline conditions, sulphides remain largely in solution. When the pH of the effluent drops below 9.5, hydrogen sulphide evolves from the effluent: the lower the pH, the higher the rate of evolution. Characterized by a smell of rotten eggs, a severe odour problem occurs.

**In its toxicity, hydrogen sulphide is comparable to hydrogen cyanide; even a low level of exposure to the gas induces headaches and nausea, as well as possible eye damage. At higher levels, death can rapidly set in, and countless deaths attributable to the build-up of sulphide in sewage systems have been recorded.**

**Hydrogen sulphide gas is also soluble. When absorbed, weak acids can form and cause corrosion. This weakens metal roofing, girders and building supports. In sewers, major problems can arise as metal fittings, structural reinforcements and piping corrode.**

If discharged into surface water, even low concentrations pose toxic hazards. Sulphides can be oxidized into non-toxic compounds by certain bacteria in rivers; however, this creates oxygen demand that, if excessive, can harm aquatic life.

### **Neutral salts**

Two common types of salts are to be found in tannery effluent:

#### **1. Sulphates (SO<sub>4</sub>)<sup>2-</sup>**

Sulphates are a component of tannery effluent which emanates from the use of sulphuric acid or products with a high (sodium) sulphate content. Many auxiliary chemicals contain sodium sulphate as a by-product of their manufacture. For example, chrome tanning powders contain high levels of sodium sulphate, as do many synthetic re-tanning agents.

Removing the sulphide component from effluent by aeration creates an additional source, since the oxidation process produces a whole range of substances, including sodium sulphate. Sulphates can be

precipitated by calcium-containing compounds to form calcium sulphate that has a low level of solubility. Problems arise with soluble sulphates, however, for two main reasons:

- a. Sulphates cannot be removed completely from a solution by chemical means. Under certain biological conditions, it is possible to remove sulphate from a solution and bind the sulphur into micro-organisms. Generally, however, the sulphate either remains as sulphate or is broken down by anaerobic bacteria to produce malodorous hydrogen sulphide. This process occurs very rapidly in effluent treatment plants, sewage systems and water courses, if effluents remain static. This bacterial conversion to hydrogen sulphide in sewage systems results in the corrosion of metal parts, and unless it is sulphate-resistant, concrete will gradually erode.
- b. If no breakdown occurs, there is the risk of increasing the total concentration of salts in surface waters and groundwater.

## **2. Chlorides (Cl<sup>-</sup>)**

Chloride is introduced into tannery effluents as sodium chloride usually on account of the large quantities of common salt used in hide and skin preservation or the pickling process. Being highly soluble and stable, it is not affected by effluent treatment and nature, thus remaining as a burden on the environment. Considerable quantities of salt are produced by industry and levels can rapidly rise to the maximum level acceptable for drinking water. Increased salt content in groundwater, especially in areas of high industrial density, is now becoming a serious environmental hazard.

Chlorides inhibit the growth of plants, bacteria and fish in surface waters; high levels can lead to breakdowns in cell structure. If the water is used for irrigation purposes, surface salinity increases through evaporation and crop yields fall. When flushed from the soil by rain, chlorides re-enter the eco-system and may ultimately end up in the groundwater.

## **Oils and grease**

In leather manufacture, natural oils and grease are released from within the skin structure. If fat liquor exhaustion is poor, some fatty substances may be produced through inter-reaction when wastewaters mingle.

Floating grease and fatty particles agglomerate to form "mats," which then bind other materials, thus causing a potential blockage problem especially in effluent treatment systems. If the surface waters are contaminated with grease or thin layers of oil, oxygen transfer from the atmosphere is reduced. If these fatty substances emulsify, they create a very high oxygen demand on account of their bio-degradability.

## **pH value**

Acceptable limits for the discharge of wastewaters into both surface waters and sewers vary, ranging from pH 5.5 to pH 10.0. Although stricter limits are often set, greater tolerance is shown towards higher pH values since carbon dioxide from the atmosphere or from biological processes in healthy surface water systems tends to lower pH levels very effectively to neutral conditions. If the surface water pH shifts too far either way from the pH range of 6.5-7.5, sensitive fish and plant life may be lost.

Municipal and common treatment plants prefer discharges to be more alkaline to reduce the corrosive effect on concrete. Metals tend to remain insoluble and more inert, and hydrogen sulphide evolution is minimized. When biological processes are included in the treatment, the pH is lowered to more neutral conditions by carbon dioxide.

### **Chromium compounds**

Metal compounds are not biodegradable. They can thus be regarded as long-term environmental features. Since they can also have accumulative properties, they are the subject of close attention. Two forms of chrome are associated with the tanning industry, and their properties are often confused.

#### **1. Chrome 3+ (trivalent chrome, chrome III)**

Chromium is mainly found in waste from the chrome tanning process; it occurs as part of the re-tanning system and is displaced from leathers during re-tanning and dyeing processes. This chrome is discharged in soluble form; however, when mixed with tannery wastewaters from other processes (especially if proteins are present), the reaction is very rapid. Precipitates are formed, mainly protein-chrome, which add to sludge generation.

Very fine colloids are also formed which are then stabilized by the chrome – in effect, the protein has been partially tanned. The components are thus highly resistant to biological breakdown, and the biological process in both surface waters and treatment plants is inhibited.

Once successfully broken down, chromium hydroxide precipitates and persists in the ecosystem for an extended period of time. If chrome discharges are excessive, the chromium might remain in the solution. Even in low concentrations, it has a toxic effect upon daphnia, thus disrupting the food chain for fish life and possibly inhibiting photosynthesis.

#### **2. Chrome 6+ (hexavalent chrome, chrome VI)**

Dichromates are toxic to fish life since they swiftly penetrate cell walls. They are mainly absorbed through the gills and the effect is accumulative. However, tannery effluents are unlikely to contain chromium in this form.

## Annex 20. References

1. *Mass balance in leather processing*, J. Buljan, J. Ludvik, G. Reich, IULTCS Congress, 1997.
2. *Pollutants in tannery effluents: Definitions and environmental impact, limits for discharge into water bodies and sewers*, M. Bosnic, J. Buljan, R.P. Daniels.
3. *Selection of equipment for laboratories monitoring pollution in the tanning industry*, M. Aloy, (English, French, Spanish, Chinese).
4. *Safety handbook: How to deal with hydrogen sulphide gas in tanneries and effluent treatment plants*, J. Hannak, G. Jayaraj.
5. *Tanneries and the environment: A technical guide*, UNEP-UNIDO, 1991.
6. *Occupational safety and health aspects of leather manufacture (OSH manual)*, J. Hannak, J. Buljan, A. Sahasranaman & CTC.
7. *Manual on landfill for tannery sludge*, V. Post, R. Swaminathan, M. Aloy, T. Poncet.
8. *Some considerations about the problem of salinity of tannery effluents*, J. Buljan, LGR, Germany, March 2004.
9. *Costs of tannery waste treatment*, J. Buljan, UNIDO Leather Industry Panel meeting, León, Mexico, September 2005.
10. *Benchmarking in the tanning industry*, J. Buljan, UNIDO Leather Industry Panel meeting, Gramado, Rio Grande do Sul, Brazil, May 2007.
11. *Ökologische Probleme der Lederindustrie*, Lieselotte Feikes, Bibliothek des Leders, Band 8, 2. Auflage, 1990.
12. <http://www.fao.org/docrep/t0551e/t0551e05.htm>
13. [http://www.waterspecialists.biz/html/about\\_coagulation\\_flocculati.html](http://www.waterspecialists.biz/html/about_coagulation_flocculati.html)  
[http://www.unep.or.jp/ietc/publications/freshwater/sb\\_summary/10.asp](http://www.unep.or.jp/ietc/publications/freshwater/sb_summary/10.asp)



**UNITED NATIONS INDUSTRIAL DEVELOPMENT ORGANIZATION**  
Vienna International Centre, P.O. Box 300, 1400 Vienna, Austria.  
Telephone: (+43-1) 26026-0. Fax: (+43-1) 26926-69.  
E-mail: [unido@unido.org](mailto:unido@unido.org) Internet: <http://www.unido.org>